

**Step 30.2** Mount the left dummy Sidewinder missile to the rack installed on the left wing tip. See 30B & 30C  
**Step 30.3** Secure the fin end (back) of the left missile to the left rack using 2x10 mm screw. See 30C.  
**Step 30.4** Secure the tip end (front) of the left missile to the left rack using 2x10 mm screw. See 30D.  
**Step 30.5** Repeat steps 30.2, 30.3 and 30.4 for the right dummy missile.

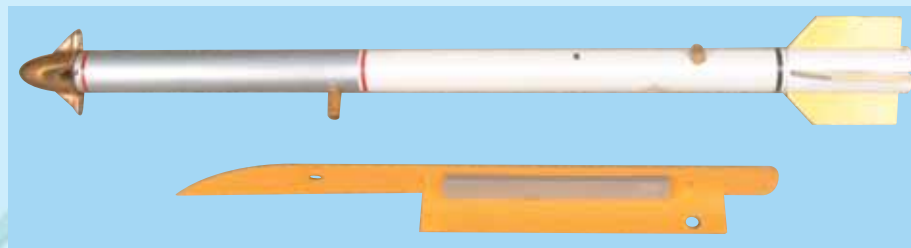

30A- Dummy Sidewinder missile and mounting rack.



30B- Mount the racks on the wing tips.

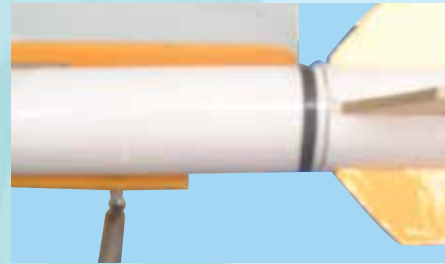

30C- Secure the back end of the missile



30D- Secure the front end of the missile



30E- Completed installation of dummy missile.



30F- The F18 HORNET (US NAVY version) with dummy Sidewinder missiles.z

For parts and support related to this product please visit us at [www.richmondrc.com/support.htm](http://www.richmondrc.com/support.htm)

For more VMAR products please visit us at [www.richmondrc.com](http://www.richmondrc.com)

HAPPY FLYING!



VMAR, V-COTE 2-3DS, VMAX and VCA are Trademarks of VMAR Manufacturing Inc. and appointed agents worldwide  
 Copyright VMAR Manufacturing Inc. #VMA-F690XIB 20060822

# F18 HORNET



## ASSEMBLY & OPERATIONS MANUAL

Please review this manual thoroughly before assembling or operating this model

### Proceeding with assembly and use of this product indicates Agreement With & Acceptance of the following Liability Disclaimer

Model airplanes, model engines, model engine fuel, propellers and related accessories, tools and equipment can be hazardous if improperly used. Be cautious and follow all safety recommendations when using your VMAR model airplane. Keep hands, tools, clothing and all foreign objects well clear of engines when they are operating. Take particular care to safeguard and protect your eyes and fingers and the eyes and fingers of other persons who may be nearby. Use only a good quality propeller that has no cracks or flaws. Stay clear of the propeller and stay clear of the plane of rotation defined by the propeller. The Manufacturer, Distributor, Retailer and/or other

suppliers of this product expressly disclaim any warranties or representations, either expressed or implied, including but not limited to implied warranties of fitness for the purposes of achieving and sustaining remotely controlled flight. In no event will the Manufacturer, Distributor, Retailer and/or other suppliers of this product have any obligation arising from contract or tort, or for loss of revenue or profit, or for indirect, special, incidental, consequential or other damages arising from the use of this product. In purchasing and/or using this product, the user accepts all responsibility for its use and accepts all liability associated with such use.

### CAUTION

A Remote Control Model Aircraft is not a toy. It is a flying model that functions much like a full size airplane. If you do not assemble and operate this product properly you can cause injury to yourself and others and damage property. DO NOT FLY this model if you are not qualified. You are entirely responsible for the mechanical,

aeronautical and electrical integrity of this model and it's structure, control surfaces, hinges, linkages, covering, engine, radio, wiring, battery and all other components. Check all components before and after each flight.

**Don't fly until it's right!**



# STAGE 1

## WING ASSEMBLY - PREPARING THE WING HALVES

### Parts needed

- Right & left wing panels
- 1 rear aluminum tube spar joiner 26-3/4 in. (680mm) long and 2/3 in. (16mm) diameter
- 1 front aluminum tube spar joiner 20-7/8 in (530mm) long and 2/3 in (16mm) diameter
- 4 laser cut plywood washers
- Four 4mm metal butterfly nuts
- 2 wing root foam gaskets
- 4 lock nuts with metal washers

**Step 1.1** Turn over the fuselage and remove the hatch cover. See 1B



1B - Bottom hatch cover removed

**NOTE:** Depending on your market area, wing bolt installation described in Steps 1.3 through 1.7 may have been completed at the factory.

**Step 1.3** To prepare each wing half, you will need 2 wing bolts 3-1/2 in (90 mm) long, 2 lock nuts and 2 washers. See 1D and 1I on page 3.

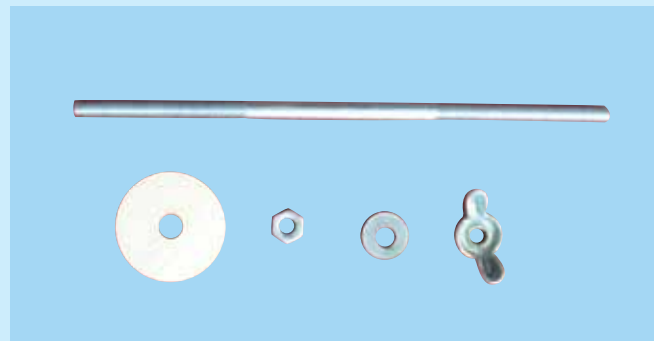

1D - Wing attachment hardware for Step 1.3 and Step 1.9

**Step 1.5** Carefully thread a lock nut onto each wing bolt so that the nut is 1 in. (25 mm) from the end of the bolt. See 1D and 1I on Page 3



1F - Apply liquid thread locker and carefully thread the short end of the wing bolt into the hidden blind nuts in the wing

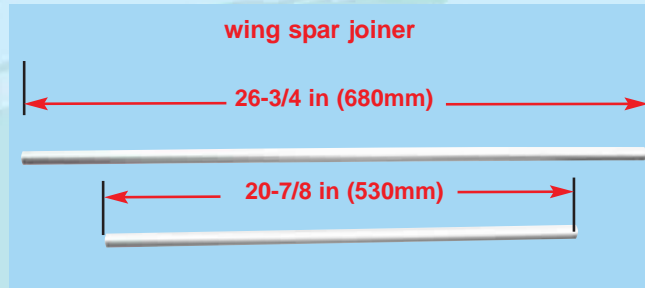

**Step 1.2** Insert the front wing spar joiner and then the rear spar joiner. See 1C

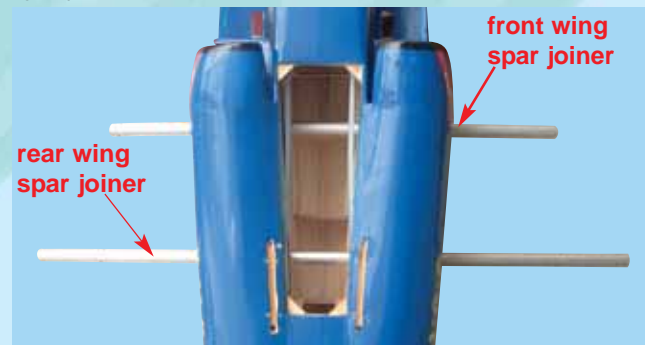

1C - Insert the wing joiners into the fuselage

**Step 1.4** Install the wing bolts into the wing. See 1E and 1I on Page 3

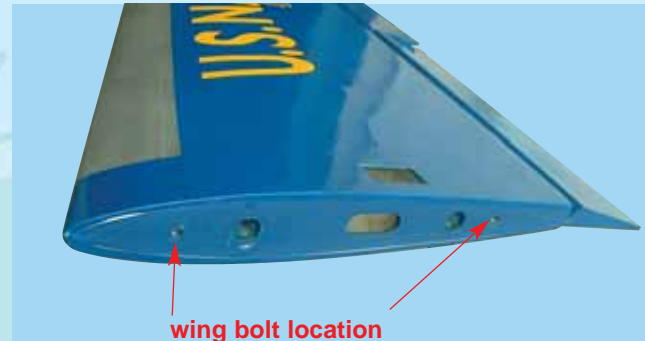

1E - The wing bolt location

**Step 1.6** Apply thread locker and carefully thread two wing bolts 4-3/4 in. (12mm) into the hidden blind nuts in each wing so that 3-3/4 in. (95 mm) of threaded bolt protrudes from each wing root. See 1F, 1G and 1I on Page 3

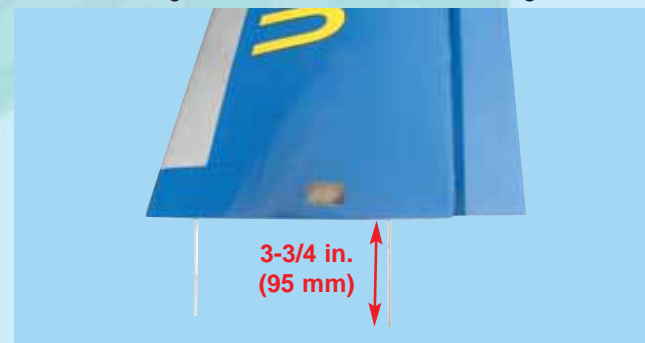

1G - Install the two wing bolts into the wing

# STAGE 28

## INSTALL THE FLAPS

The F18 HORNET comes with flaps. If you do not plan on using the flaps, secure them in a neutral position. To activate the flaps, install the control linkages & servos as shown in 28A, 28B & 28C.

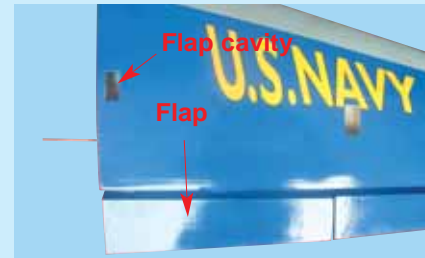

28A - Flap ad flap servo cavity location

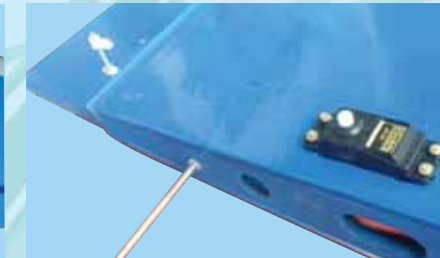

28B - Install the flap servos and flap control horns



28C - Install the flap control rods between the servos and the horns.

# STAGE 29

## INSTALL THE DUMMY FUEL TANKS

The dummy fuel tank can be mounted to the wooden hatch using the following procedure:

**Step 29.1** Remove the wooden hatch from the fuselage

**Step 29.2** Use sheet metal screws to mount the dummy fuel tank to the hatch

**Step 29.3** Re install the hatch to the fuselage



29A - Dummy fuel tanks and mounting racks



29B - Hatch remove from fuelage

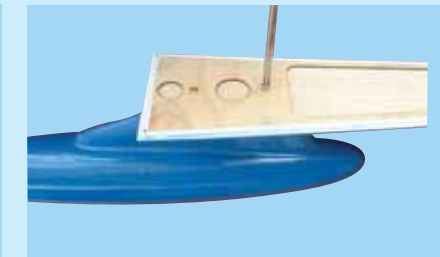

29C - Mount the dummy fuel tank to the hatch

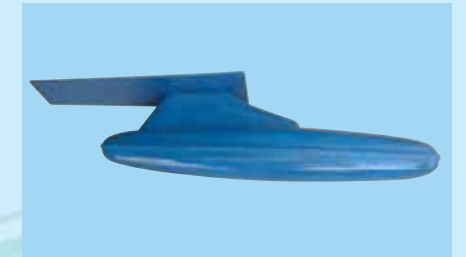

29D - Dummy fuel tank mounted to the hatch



INSTALL THE DUMMY FUEL TANK AS SHOWN.

# STAGE 30

## INSTALL THE DUMMY SIDEWINDER MISSILES.

The VMAR F18 HORNET Navy version comes with simulated dummy missiles and missile mounting racks. In some markets the racks may not be pre-installed for ease of shipping.

### PARTS NEEDED

- Right and left dummy missile mounting racks
- Right and left dummy Sidewinder missiles.

**Step 30.1** Install the dummy missile mounting racks to the wing tips. See 30A and 30B.

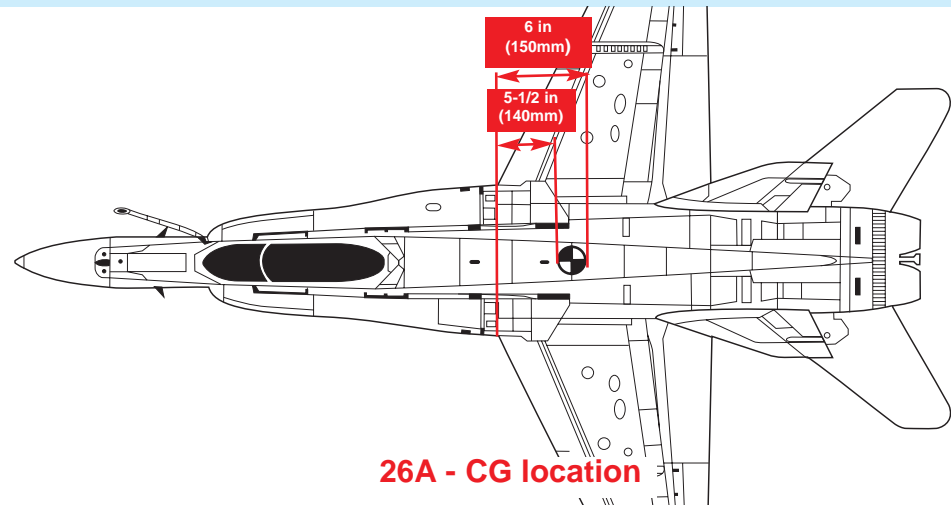

26A - CG location

## STAGE 27 CONFIRM MECHANICAL INTEGRITY

Once you have confirmed that the CG is correct, you should do a thorough review of the entire model before your first flight. Check everything twice! Every hook up, every coupling, everything! Do it twice!!

Before your first flight, have an experienced flyer review your work. Do not fly your model until it has been checked

### CONTROL SURFACE THROW SPECIFICATIONS:

The throws are measured at the widest part of the control surface. Adjust the position of the pushrods at the control and/or servo horns to control the amount of throw. You may

out by a third party who knows how to fly and how to set up a model aircraft. Do not fly alone. Seek experienced help.

Once you have completed your first flight, get in the habit of checking your model over before and after each flight! Don't fly if you find something that is not right!

also use ATV's if your radio has them but the mechanical linkages should still be set so that the ATV's are near 100% for best servo resolution.



	Low rate		High rate
ELEVATOR	1/3" (8mm) up		1/2" (12 mm) up
	1/3" (8mm) down		1/2" (12 mm) down
AILERON	1/3" (8 mm) up		1/2" (12 mm) up
	1/3" (8 mm) down		1/2" (12 mm) down
RUDDER	5/8" (16 mm) right		1" (25 mm) right
	5/8" (16 mm) left		1" (25 mm) left

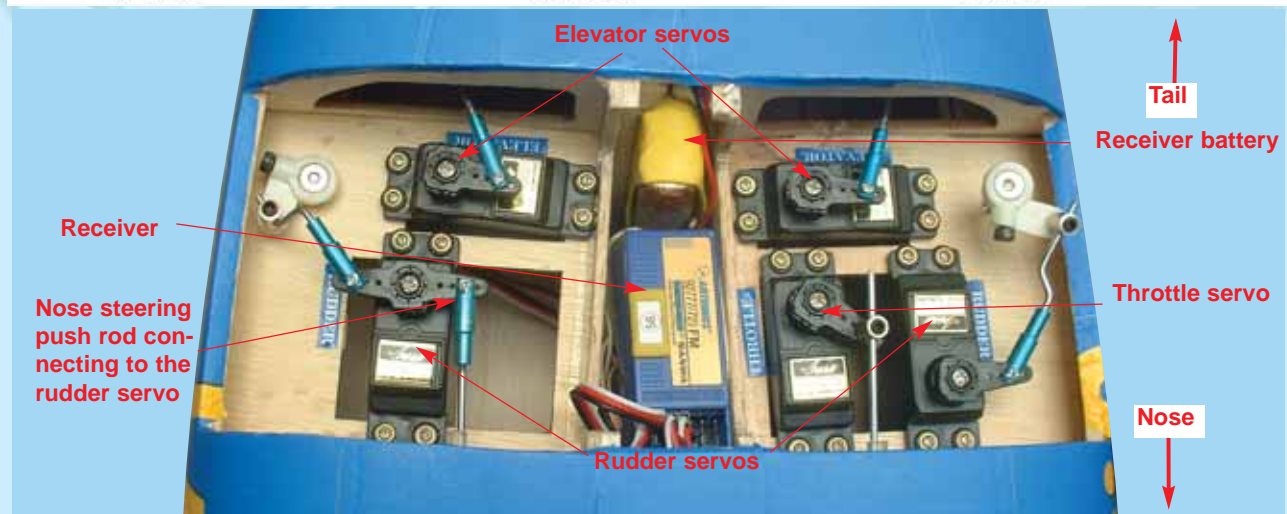
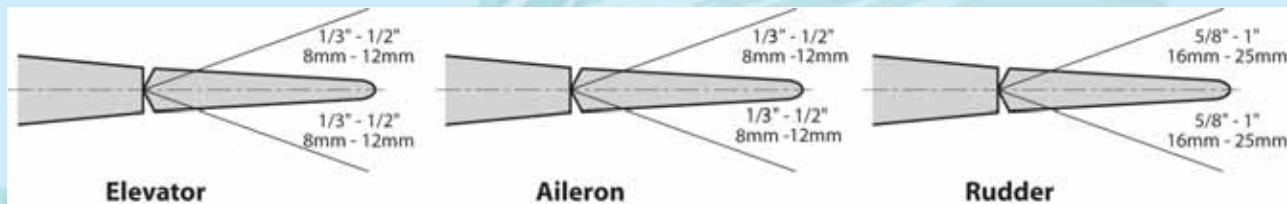

27A- TYPICAL SERVOS PUSH ROD RECEIVER AND RECEIVER BATTERY ARRANGEMENT

**Step 1.7** Secure the wing bolt to the wing by tightening the lock nut. See 1H



CAUTION: Tighten snugly but DO NOT OVERTIGHTEN

1H - Hold the wing bolt while tightening the lock nut

**Step 1.8** While holding the aluminum tubes centered in the fuselage, carefully slide each wing half onto the tubes and flush the wing root against the side of the fuselage. See 1J



1J - Plug the wing panels into the fuselage

**Illustration 1I:** Typical installation of the wing bolts into the pre-installed blind nuts located inside the wing so that 3 in. (75 mm) of each wing bolt protrudes from the wing root.

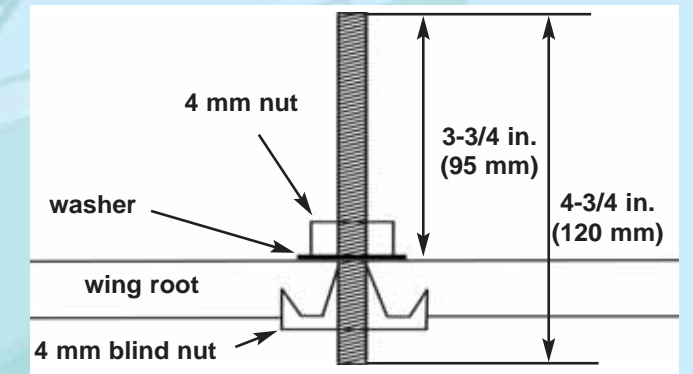

1I - Typical installation wing bolt to the wing

**Step 1.9** Place flat washers over the wing bolts and then install the butterfly nuts. Do NOT overtighten. For double security also install the lock nuts. See 1K

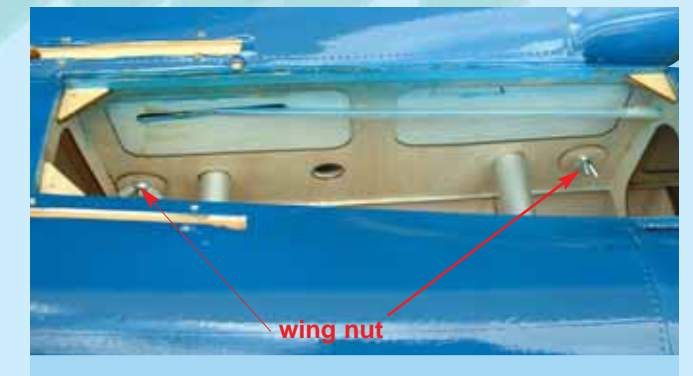

1K - Tighten the wing nuts. DO NOT OVERTIGHTEN. For double security also install the lock nuts

## STAGE 2 INSTALLING THE AILERON SERVOS INTO THE WING

To install the aileron servos into the wing you will need the following items:

- Servos
- Servo mounting screws and grommets as supplied with servos
- Servo control arms as supplied with servos
- Two aileron control rod assemblies supplied with the kit. The assemblies consist of a metal rod with a clevis on each end
- Low tack masking tape
- 2 aileron control horn assemblies

**Step 2.1** Turn the wings upside down and locate the aileron servo cavities. See 2B

**Step 2.2** Trial fit the aileron servo into the servo mounting cavity. You may have to modify the cavity slightly to provide clearance for the servo and servo wires. Use a hobby knife to modify the cavity as required. Most servos have their output shaft closer to one end than the other. We recommend locating the servo so that the output shaft is as close to the rear of the wing as possible.



2A - Prepare the servos by fitting the rubber grommets & ferrules supplied with your servos



2B - Aileron servo location

**Step 2.3** Screw the servo into place with the screws and grommets supplied. It is important to install the grommets and screws correctly. See the manual that came with your radio for instructions about your particular servo grommets. See 2C

**Step 2.4** Fasten the screws down according to the servo manufacturers recommended tightness.

**Step 2.5** Repeat this procedure for both wing servos.



2C - Mount the aileron servos into the wing

## STAGE 3 INSTALLING THE AILERON CONTROL SYSTEM

**Step 3.1** Consult your radio instruction manual and center each aileron servo by plugging it into the aileron channel in the receiver. Turn on the transmitter and then the receiver. Center the aileron trim lever on the transmitter. Remove the servo arm mounting screw and the servo arm.

**Step 3.2** Mount the servo arm back on the servo. Position the arm to be parallel with the back edge of the wing. Screw the arm into place with the servo arm mounting screw supplied with the servo. Locate the two aileron control rods in the hardware bag. Ensure the clevises are screwed well onto the threaded portion of the rod. Rotate and tug aggressively on the clevises and ensure that they are not loose on the rods. Tape the ailerons into their neutral position so that they are even with the trailing edge of the wing and not pointing either up or down.

**Step 3.3** Ensure that the aileron control horns are screwed onto the threaded aileron control horn bolts and that both control horns are in approximately the same place on their respective bolts. See 3B

**Step 3.4** Connect the aileron servo rods to the aileron control horns. Connect the control rod to the servo output arm using a clevis. See 3C

**Step 3.5** Connect the other end of the control rod to the control horn using the second clevis. See 3C

**Step 3.6** Remove the masking tape holding the aileron.

**Step 3.7** In the case of computer radios couple the servos together electronically by connecting them to the appropriate receiver channels. In the case of analog radios couple the servos together using a Y harness.

**Step 3.8** Turn on your radio and activate the ailerons, using the aileron stick and ensure a smooth full motion can be achieved.

**Step 3.9** With the wing top side up and viewed from the back, ensure that moving the transmitter aileron stick to the left raises the left aileron and lowers the right aileron. Movement of the stick to the left will roll the aircraft to the left. (Counterclockwise roll of the wing when viewed from the back).

**Step 3.10** With the wing top side up and viewed from the back, ensure that moving the transmitter aileron stick to the right raises the right aileron and lowers the left aileron. Movement of the stick to the right will roll the aircraft to the right.



3A - Aileron control rod assembly

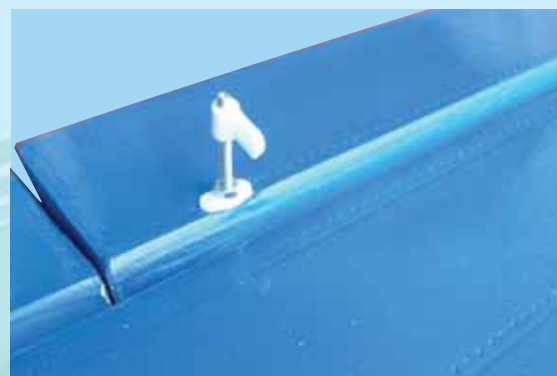

3B - Aileron control horn installed



3C- Aileron control rod installed

## STAGE 23 INSTALLING THE RECEIVER BATTERY

**Step 23.1** Consult your radio manual for instructions about hooking up your receiver battery, receiver and switch harness.

**Step 23.2** Wrap the battery pack securely in foam suitable for RC equipment and wrap the foam insulated pack in a plastic bag or cling wrap. Position the battery pack as

shown in 24B.

**Step 23.3** Thread the battery pack connector forward in preparation for connecting to your switch harness.

**Step 23.4** Connect the battery pack connector to your switch harness according to your radio manual.

## STAGE 24 INSTALLING THE RECEIVER

**Step 24.1** Consult your radio manual for instructions about hooking up your receiver.

**Step 24.2** Plan where you are going to put the receiver with consideration for routing the antenna safely.

**Step 24.3** Wrap the receiver securely in foam suitable for RC equipment and wrap the foam insulated receiver in a plastic bag or cling wrap.

**Step 24.4** Install your receiver near the aft end of the fuselage as shown in 24B.



24A - Location of servos at aft end of fuselage

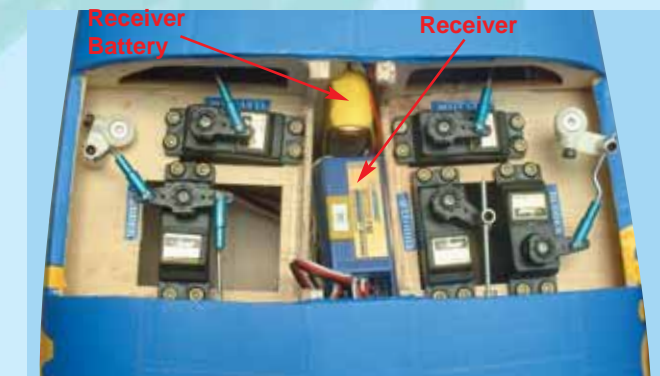

24B - Receiver battery and receiver location

## STAGE 25 CONFIRM RADIO OPERATION

**Step 25.1** Consult your radio manual for instructions about testing and operating your radio system.

**Step 25.2** Pay particular attention to charging your radio system batteries and range testing the system before and after each flight.

**Step 25.3** Check that all controls are working correctly before and after each flight.

## STAGE 26 BALANCING THE AIRCRAFT

The CG for your F18 HORNET is located at 5-1/2 in. to 6 in. (140-150 mm) back from the leading edge of the wing when the wing has been attached to the fuselage.

For the initial flight, the CG should be located at 5-1/2 in. (140mm) back from the leading edge of the wing when the wing has been attached to the fuselage.

The CG is measured with the engine, radio gear and all other components installed but WITH NO FUEL IN THE TANK.

After gaining some experience flying the F18 HORNET the location of the CG can be shifted slightly further aft to a location not more than 6 in. (150mm). back from the leading edge of the wing when the wing has been attached to the fuselage. Set the CG with NO FUEL IN THE TANK.

It is very important to have the CG correct. Flying your

model with the CG too far back (aft) will likely lead to loss of control and a crash. If you discover that after you have assembled your model and installed your radio and engine that the CG of your model is incorrect you must bring the CG to the correct location by doing the following BEFORE FLYING :

- Move the battery pack fore or aft.
- Move other components fore or aft.
- Change engine to a lighter or heavier model.
- Add weight to the nose or tail. If adding it to the nose, try to make it useful by going to a heavier duty engine or adding a spinner with a heavy metal backing plate. As a last resort, add stick on "dead" weight where appropriate.

**Step 19.3** Connect the control rods between the rudder servo arms & the rudder control horns. See 19B, 19C & 19D

**Step 19.4** Connect the nose gear steering rod to the rudder servo as shown in 19D and 19E.



19C - With the servos and rudders at neutral, connect the clevises and then tighten the control horn set screws.

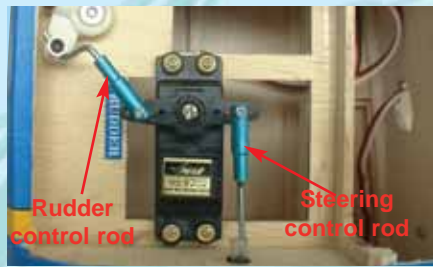

19D - Connect the nose gear steering control rod.

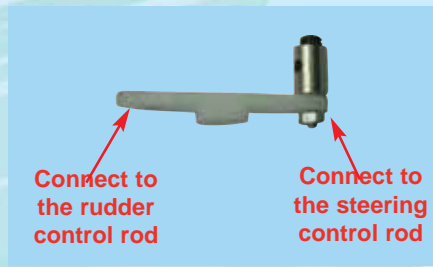

19E - Connecting the steering control rod to the servo arm.

**NOTE:** In most market areas, the EZ connector shown has been replaced by a clevis.

## STAGE 20 INSTALL & ADJUST THE THROTTLE CONTROL

With the throttle control arm clevis connected to the engine throttle arm, move the throttle arm to roughly half throttle. Look into the throat of the engine carburetor as you rotate

the throttle arm and select a position where the throttle opening is about half what it is when fully open. Install and connect the throttle servo.



20A - The throttle arm and clevis connected to the engine throttle arm

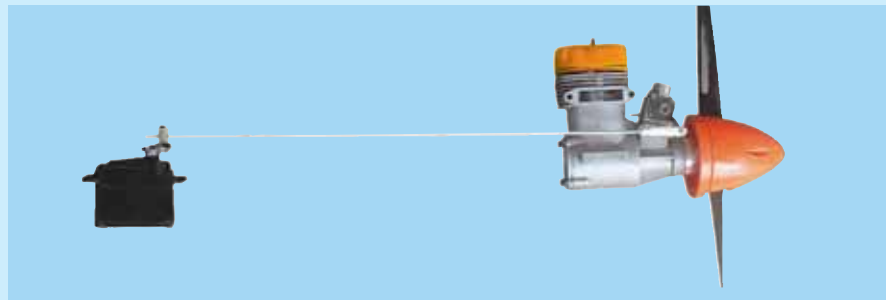

20B - The throttle servo controls the engine throttle using the throttle control rod

## STAGE 21 ADJUST CONTROL SURFACE THROW LIMITS

Adjust the deflection of the control surfaces to match the specifications on page 14. You can reduce the amount of throw by doing either or both of the following:

- From the servo end, move the clevis or EZ connector to a hole in the servo arm that is closer to the servo output shaft.

- From the control horn end, move the horn out further on the threaded bolts. Always confirm that the horn is still thoroughly engaged with the threaded bolt after you have adjusted it.

## STAGE 22 FINAL RC SET-UP

**Step 22.1** Before starting the final set-up of the model, switch on the radio and ensure that all trims are in their neutral positions. Check that the aileron, elevator and rudder are centered. If any adjustments are needed, do these by uncoupling the relevant clevis and turning it clockwise to shorten the linkage or counter-clockwise to lengthen it. Only when each control surface has been centered

mechanically in this way should you begin adjusting the surface movement (or throw).

**Step 22.2** Now confirm that the control surfaces are moving in the correct direction. Use the servo reversing switches on your transmitter to reverse the direction of a servo if necessary.

## STAGE 4 FITTING THE VERTICAL AND HORIZONTAL STABILIZERS

To install the stabilizers into the fuselage you will need:

- Fuselage
- 2 Vertical stabilizers with pre-installed rudders
- Right and left horizontal stabilizers with pre-installed elevators

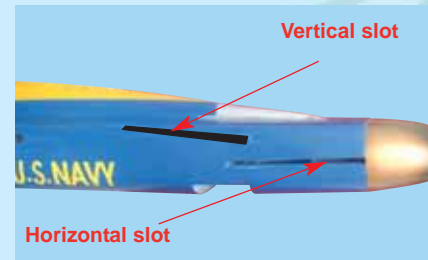

4A - The fuselage slots for the vertical & horizontal stabilizers

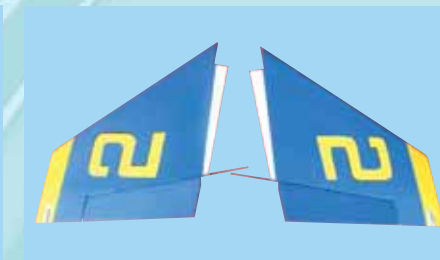

4B - 2 Vertical stabilizers with pre-installed rudders

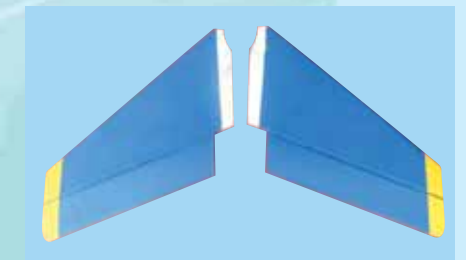

4C - Horizontal stabilizers with pre-installed elevators

## STAGE 5 INSTALL THE VERTICAL STABILIZER

**Step 5.1** The F18 has two vertical stabilizers. See 5A. Check the fit of the vertical stabilizers in their slots. Make sure the rudder control rods fit into the rudder hole guides. See 5B & 5C. **Do not glue anything yet!**

**Step 5.2** Remove both vertical stabilizers from the fuselage. Apply sufficient 30 minute epoxy into the right fuselage slot for the right vertical stabilizer. Use 30 minute epoxy only. See 5D. **Do not apply epoxy near the rudder hole guide**

**Step 5.3** Apply sufficient 30 minute epoxy to the exposed wood on both sides of the right vertical stabilizer. Use 30 minute epoxy only. See 5E. **Do not apply epoxy near the rudder control rod.**

**Step 5.4** Install the left vertical stabilizer using sufficient 30 minute epoxy and the same procedure. Carefully wipe off any excess epoxy.



5A - Vertical stabilizer with pre-installed rudder and rudder control rod

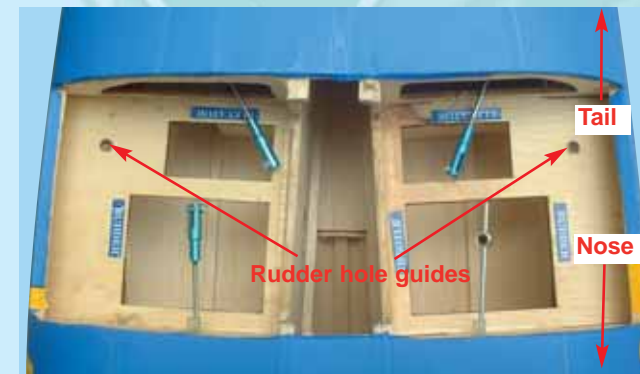

5B - Rudder hole guides.



5C - Trial fit the vertical stabilizer in its slot



5D - Apply plenty of epoxy into the fuselage slot for the vertical stabilizer



5E - Apply sufficient epoxy to both sides of the exposed wood



5F - Slide the vertical stabilizer into place. Wipe off any excess epoxy

## STAGE 6 INSTALL THE HORIZONTAL STABILIZERS

**Step 6.1** Locate the left and right horizontal stabilizers. See 6A

**Step 6.2** Trial fit the right and left horizontal stabilizers into the fuselage slots. See 6B. **Do not glue anything yet!**

**Step 6.3** Remove both horizontal stabilizers. Apply sufficient epoxy to the exposed wood of the left horizontal stabilizer and into the left slot in the fuselage. Use 30 minute... See 6C.

**Step 6.4** Insert the left horizontal stabilizer into the fuselage slot and adjust to match the distances shown in 6D.

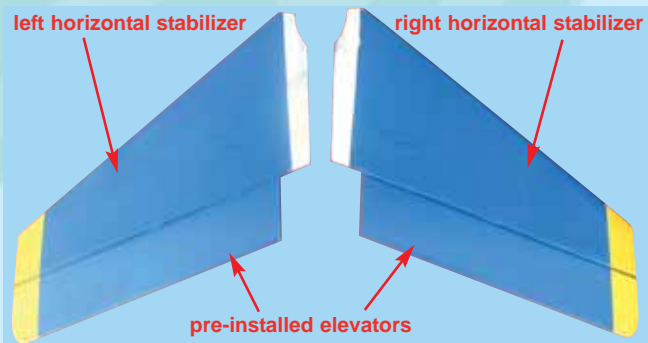

6A - Left and right horizontal stabilizers with pre-installed elevators



6B - Trial fit the horizontal stabilizers into the fuselage slots



6C - Apply sufficient epoxy to the exposed wood area



6D - Insert the left horizontal stabilizer into the fuselage and adjust the distance

**Step 6.5** Repeat step 6.4 for the right horizontal stabilizer.

**Step 6.6** Wipe off the excess epoxy. See 6E



6E - Wipe off the excess epoxy



6F - Vertical and horizontal stabilizers installed.

## STAGE 7 INSTALL THE LANDING GEAR

The F18 HORNET has a tricycle gear configuration (trike gear) using a steerable nose wheel and main landing gear



**Step 16.1** The elevator control horns are installed through the elevators and protrude from the bottom of the elevators. Pierce the covering over the pre-drilled holes and install the control horns as shown. See 16B&16C

**Step 16.2** The rudder control rod (arm) runs through the rudder hole guide and exits into a cavity on the bottom of the fuselage beneath the rudders

**Step 16.3** Install the supplied rudder control horn assemblies. See 16D. Loosely tighten the set screws only at this point.

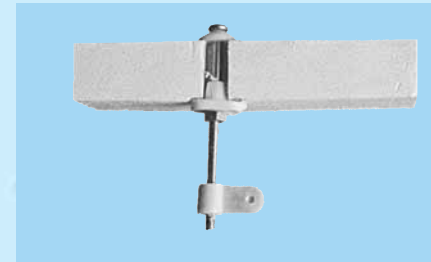

16B - Typical control horn mounted to the control surface



16C - Elevator control horns installed



16D - Rudder control horns installed

## STAGE 17 INSTALLING THE SERVOS

Install the rubber servo grommets and brass ferrules supplied with your radio equipment. The 5 servos that control the 2 elevator surfaces, 2 rudders and throttle are to be installed in the servo cavities located towards the back of the fuselage. See 17A & 27A



17A - Location of the 2 elevator, 2 rudder and throttle servos.

## STAGE 18 CONNECTING THE PUSHRODS TO THE ELEVATOR

The F18 HORNET has two separate elevators and two separate elevator control rods each running to an independent servo.

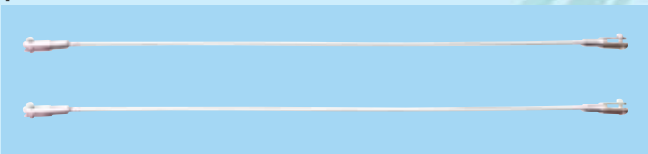

18A - Elevator control rod assemblies 8-3/4 in. (222 mm)

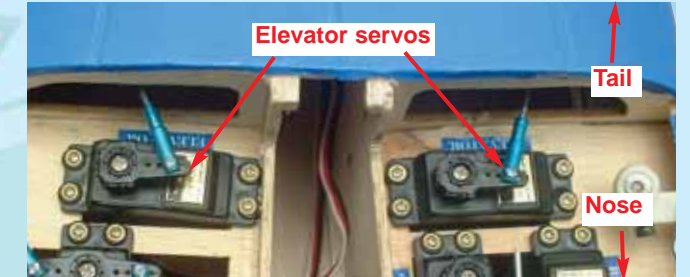

18B - Connecting the elevators to the servos

## STAGE 19 CONNECTING THE RUDDERS TO THE RUDDER SERVOS

**Step 19.1** The 2 control rods connected to the rudders exit inside the fuselage. Attach and secure the rudder control horns to the rods as illustrated in 19A.

**Step 19.2** Install your rudder servos as shown in 17A and 19B. Connect the rudder servos to your receiver. Power up the receiver and center the servos at neutral.



19A - Connect the 2 rudder control rods to the rudder control horns.

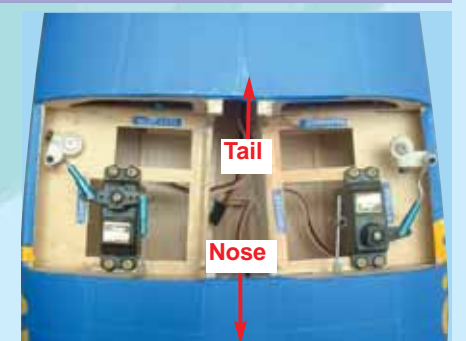

19B - Install the rudder servos. Connect the control rods between the servo arms & the rudder control horns.

## STAGE 13 CONNECTING THE THROTTLE CONTROL ROD TO THE ENGINE.



13A - Connect the clevis to the engine throttle arm



13B - Connect the servo arm to the engine throttle arm using the throttle control rod

## STAGE 14 CONNECTING THE FUEL LINES

**Step 14.1** Install the muffler. Connect the fuel tank pressure line to the muffler pressure nipple.

**Step 14.2** Connect the fuel tank fuel line to the carburetor fuel inlet nipple.

**Step 14.3** Double check that you have connected the metal fuel line from the tank to the carburetor and that you have connected the metal pressure line from the tank to the muffler.

**Step 14.4** The fuel tank refueling line is used only when filling the tank. Keep the line plugged after fueling is completed.



## STAGE 15 INSTALL THE PROPELLER AND THE SPINNER

**Step 15.1** Consult your engine manual and select a suitable propeller. See 15A

**Step 15.2** Install the thrust washer, the spinner backing plate, the propeller, the prop washer, and the prop nut supplied with the spinner. Ensure that they are all firmly attached. See 15B, 15C

**Step 15.3** Trial fit the spinner cone and spinner cone retaining screw. If necessary enlarge the cutouts in the spinner cone to allow adequate clearance for the propeller. See 15D

**Step 15.4** Double check that the spinner cone retaining screws are firmly attached.

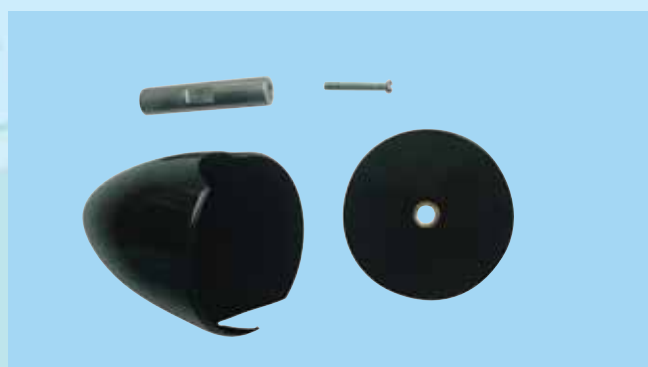

15A - Aluminum spinner complete with all hardware (supplied)



15B - Install the spinner backing plate



15C - Install the propeller, the prop washer and the prop nut



15D - Install the spinner cone using the retaining screw. Ensure the retaining screw is tight and secure

## STAGE 16 FITTING ELEVATOR AND RUDDER CONTROL HORNS

## STAGE 8 INSTALLING THE MAIN LANDING GEAR

Identify the main landing gear components shown below:

- 2 pre-bent oleo main landing gear sets pre-assembled with struts, wheels and mounting plates.
- 8 sheet metal screws (3x15 mm)
- 4 plastic landing gear straps

**Step 8.1** Turn over the fuselage to locate the pre-drilled main landing gear mounting cavities. See 8B

**Step 8.2** Insert one of the pre-assembled main landing gear into place. Use 4 sheet metal screws and two straps to attach the landing gear to the fuselage. See 8C.

**Step 8.3** Repeat step 8.2 to attach the second main landing gear to the fuselage.



8A - Components of one main landing gear with oleo strut.



8B - Main landing gear location on the fuselage



8C - Mount the main landing gear to the fuselage.



8D - Both main landing gear mounted to the fuselage.

## STAGE 9 INSTALLING THE NOSE GEAR

Identify the nose gear components per illustration 9A

- 1 completed oleo nose gear assembly with strut, strut support and wheels
- 1 steering arm with pre-installed EZ-connector
- 1 4mm collar

**Step 9.1** Review illustrations 9A, 9B and 9C then insert the front nose gear oleo strut and support strut into the mounting holes in the bottom of the fuselage.

**Step 9.2** Use the 4mm collar with set screw to secure the support strut in place. See 9D.

**Step 9.3** After securing the support strut into place, carefully pull the oleo strut back out of its fuselage hole. See 9E. Do not detach the support strut.

**Step 9.4** Working inside the fuselage, pass the nose gear steering rod through the EZ connector attached to the steering arm. See 9F. Do not tighten the steering arm set screw yet.

**Step 9.5** Working from outside the fuselage carefully re-insert the oleo strut back into its fuselage hole and then from inside the fuselage pass the oleo wire through the steering arm. See 9G. Tighten the steering arm set screw.

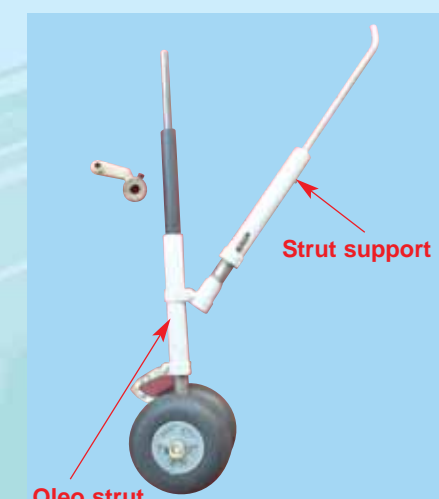

9A - Oleo nose gear & strut assembly

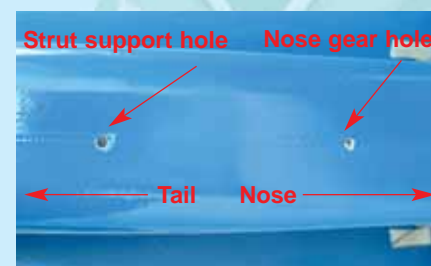

9B - Turn over the fuselage & locate the mounting holes for the oleo strut and the support strut.



9C - Insert the front nose gear oleo strut and the support strut.



9D - Use the 4mm collar and set screw to secure the support strut.

**Step 9.6** Align the nose gear straight ahead and secure the EZ connector to the nose gear steering rod by tightening the EZ connector set screw. See 9H.



9E - Carefully pull the nose gear oleo strut out of the fuselage.



9F - Pass the nose gear steering rod through the EZ connector. Do not tighten yet.



9G - After re-inserting the nose gear oleo strut, align and tighten the steering arm set screw.



9H - Align and secure the EZ connector to the nose gear steering rod using the set screw.



9I - Completed installation of the main and nose gear assemblies.

## STAGE 10 FITTING THE FUEL TANK

To assemble the fuel tank you will need the following items:

- The fuel tank and fuel stopper assembly (supplied)
- 2 clunks (supplied)
- About 10 in. (25.4 cm) of medium ID silicone fuel line (DUB-197 or DUB-222 or similar)

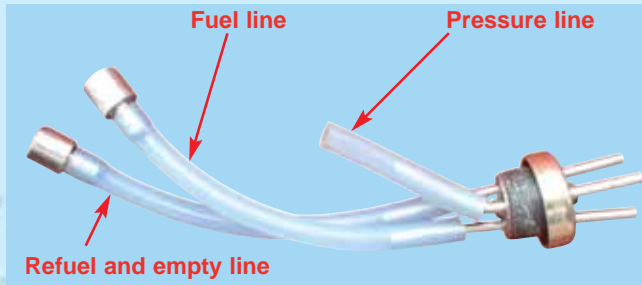

10A - Use 2 in. (50 mm) for the pressure line and 4 in. (100 mm) for the fuel and refuel lines.

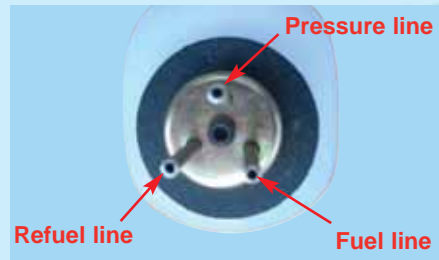

10B - Fuel tank and stopper assembly (front view)

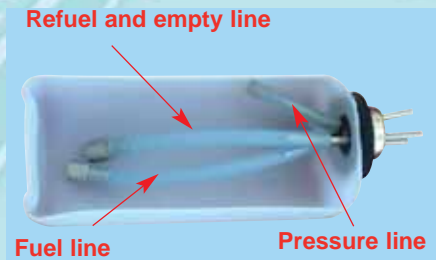

10C - Illustration of fuel line positioning inside cutaway of the tank



10D - Fuel tank installed into the fuselage after adding external fuel lines from tank forward to engine area

## STAGE 11 INSTALLING THE FUEL TANK INTO THE FUSELAGE

**Step 11.1** Remove the external screws and carefully detach the canopy from the fuselage. Then remove the internal screws and detach the pilots and instrument panel from the fuselage. See 11A

**Step 11.2** Install the fuel tank into the fuselage. Use foam sheet (supplied) to cradle the tank. See 11B

**Step 11.3** Run external pressure, fuel and refuel lines through the firewall from the tank to the engine area. Protect the tubes from contamination See 11C

**Step 11.4** After trial fitting the tank and tubing, apply silicone sealant to both sides of the black foam rubber like gasket and around neck of the tank. Press tank firmly against former. Hold in place until sealant cures.

**Step 11.5** Re-install the instrument panel and pilots into the fuselage using the internal screws. Then re-install the canopy using the external screws See 11D



11A - Remove the cockpit and instrument panel from the fuselage



11B - Fuel tank assembly in position



11C - Run external pressure, fuel and refuel lines through the firewall from the tank to the engine area



11D - Re-install the pilots, instrument panel and canopy

## STAGE 12 INSTALLING THE ENGINE

The VMAR F18 HORNET is designed for .60 to .90 size two stroke engines. The model has not been designed to accommodate four stroke or gas powered engines.

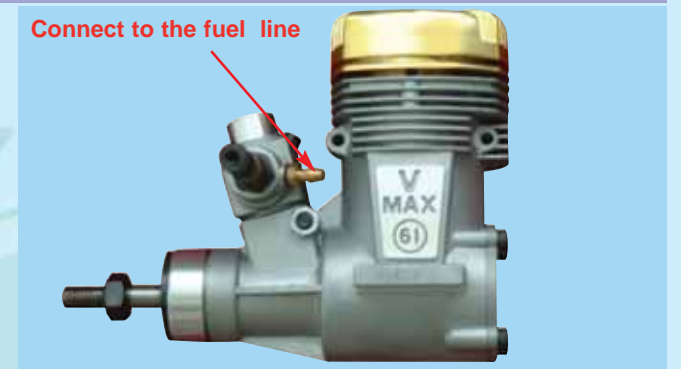

12A - .60-.90 2 cycle engine. VMAX 61PRO shown

**Step 12.1** Trial fit your engine to the engine mount. Check engine compartment clearances and modify using a Dremel tool to allow your engine to sit properly on the mounts. Ensure the spinner back plate clears the front of the fuselage by 1/16 - 3/32 in. (1.5 - 2.5 mm). See 12B

**Step 12.2** Once you have positioned the engine on the mounting beams, mark the location of the engine mounting holes. See 12C

**Step 12.3** Center punch the hole locations on the beams. Drill 3/32 in. (2.5mm) pilot holes at right angles through the beams. Put a drop of oil in each hole. Use four #4 x 25 mm sheet metal screws to mount the engine. See 12D



12B - Allow for gap between the spinner back plate and the fuselage



12C - Mark the location of the engine mounting holes



12D - Drill 3/32 in. (2 mm) pilot holes at right angles through the beams