

DHC 6 TWIN OTTER



ASSEMBLY & OPERATIONS MANUAL

Please review this manual thoroughly before assembling or operating this model.

Proceeding with assembly and use of this product indicates Agreement With & Acceptance of the following Liability Disclaimer.

Model airplanes, model engines, model engine fuel, propellers and related accessories, tools and equipment can be hazardous if improperly used. Be cautious and follow all safety recommendations when using your VMAR model airplane. Keep hands, tools, clothing and all foreign objects well clear of engines when they are operating. Take particular care to safeguard and protect your eyes and fingers and the eyes and fingers of other persons who may be nearby. Use only a good quality propeller that has no cracks or flaws. Stay clear of the propeller and stay clear of the plane of rotation defined by the propeller. The Manufacturer, Distributor, Retailer and/or other

suppliers of this product expressly disclaim any warranties or representations, either expressed or implied, including but not limited to implied warranties of fitness for the purposes of achieving and sustaining remotely controlled flight. In no event will the Manufacturer, Distributor, Retailer and/or other suppliers of this product have any obligation arising from contract or tort, or for loss of revenue or profit, or for indirect, special, incidental, consequential or other damages arising from the use of this product. In purchasing and/or using this product, the user accepts all responsibility for its use and accepts all liability associated with such use.

CAUTION

A Remote Control Model Aircraft is not a toy. It is a flying model that functions much like a full size airplane. If you do not assemble and operate this product properly you can cause injury to yourself and others and damage property. **DO NOT FLY** this model if you are not qualified. You are entirely responsible for the mechanical,

aeronautical and electrical integrity of this model and it's structure, control surfaces, hinges, linkages, covering, engine, radio, wiring, battery and all other components. Check all components before and after each flight.

Don't fly until it's right!



POLYCOTE™ ECS
ENHANCED COVERING SYSTEM



The Graphics and Detailing are inside the POLYCOTE ECS!

STAGE 1

INSTALLING ENGINE MOUNT TO THE WING

Step 1.1 The DHC6 Twin Otter has 2 motor mounts to be attached to the wing. See 1A & 1B.

Step 1.2 Locate the engine mount rails in the wing. See 1B and 1C

Step 1.3 Trial fit one of the engine mounts shown in 1A to the Wing. See 1B, 1C and 1D.

Step 1.4 Remove the engine mount from the wing. Apply sufficient 30 minute epoxy to the top & bottom engine

mount rail (see 1E & 1F) and the mating surfaces of the engine mount.

Step 1-5 Carefully slide the engine mount onto the engine mount rails. Wiggle it fore and aft several times to co-mix the epoxy then slide the engine mount firmly aft and into place on the wing. See 1G

Step 1.6 Repeat steps 1.2 - 1.5 for the second engine mount



1A- Engine Mount (factory assembled, 2 mounts)

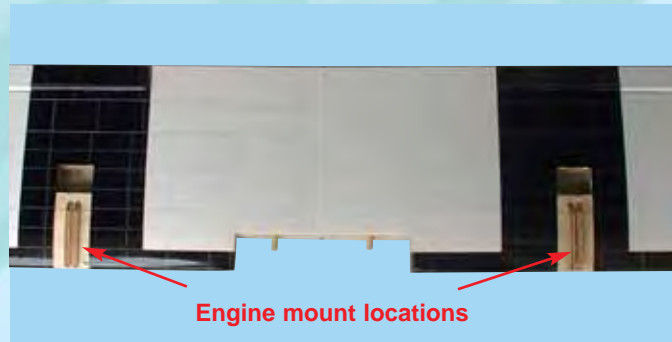

1B- Engine mount locations

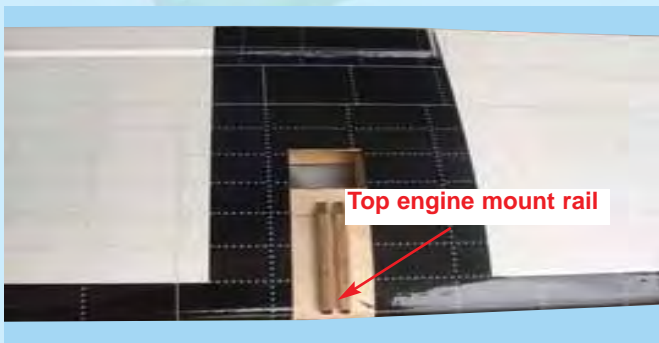

1C- Pre-installed engine mount rail

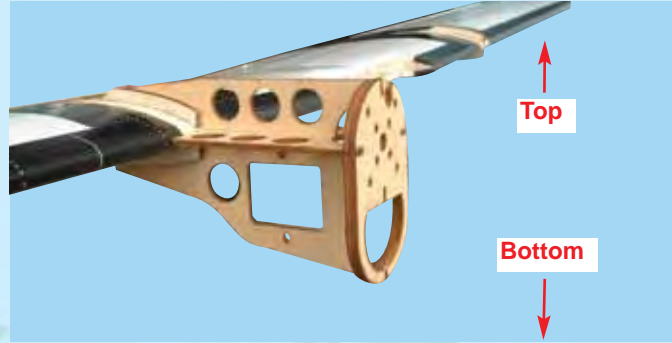

1D- Trial fit both engine mounts to the wing **BEFORE GLUING**



1E- Apply 30 minute epoxy to the top wing engine mount rail

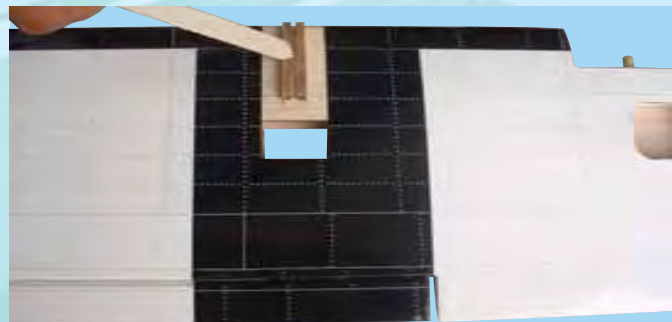

1F- Apply 30 minute epoxy to the appropriate bottom engine mount rail



1G- Install the engine mount and hold in place while the epoxy cures.

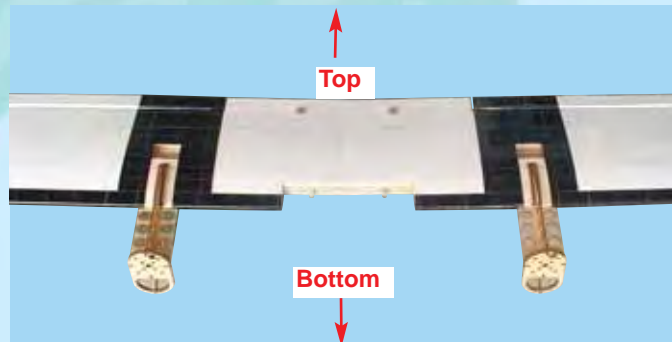

1H- Install the 2 engine mount to the wing

STAGE 2

INSTALLING THE AILERON SERVOS INTO THE WING

To install the aileron servos into the wing you will need the following items:

- 2 micro servos
- Servo mounting screws and grommets as supplied with the servos
- Servo control arms as supplied with the servos
- Two aileron control rod assemblies supplied with the kit. The assemblies consist of a rod with a clevis screwed onto both ends
- Low tack masking tape
- 2 aileron control horn assemblies

Caution: The wing strut anchors and aileron servos are located in 2 shared cavities in the bottom of the wing.

Step 2.1 Turn the wing bottom side up. Install a wing strut anchor. See 2A

Step 2.2 Trial fit the aileron servo into the servo mounting cavity. You may have to modify the cavity slightly to provide clearance for the servo and servo wires.

Step 2.3 Use a hobby knife to modify the cavity as required. Most servos have their output shaft closer to one end than the other. Mount the servo so that the output shaft is closer to the trailing edge of the wing.

Step 2.4 Screw the servo into place with the screws and grommets supplied. It is important to install the grommets and screws correctly. See the manual that came with your radio for instructions about your particular servo grommets.

Step 2.5 Fasten the screws down according to the servo manufacturers recommended tightness.

Step 2.6 Repeat steps 2.1 to 2.5 for the second aileron servo and wing strut anchor.

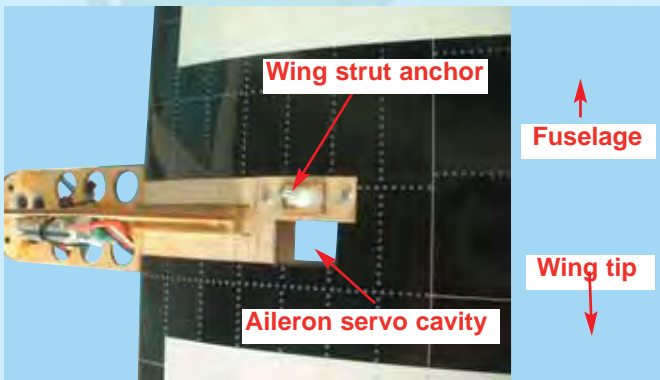

2A- Bottom view of typical location of aileron servo & wing strut anchor.



2B- Install servo using the rubber grommets & ferrules supplied with the servo.

STAGE 3

PREPARING THE HORIZONTAL AND VERTICAL STABILIZERS

To install the stabilizers into the fuselage you will need:

- Fuselage
- Vertical stabilizer with pre-installed hinges
- Rudder
- Horizontal stabilizer with pre-installed elevator



3C- Vertical stabilizer with pre-installed hinges and rudder

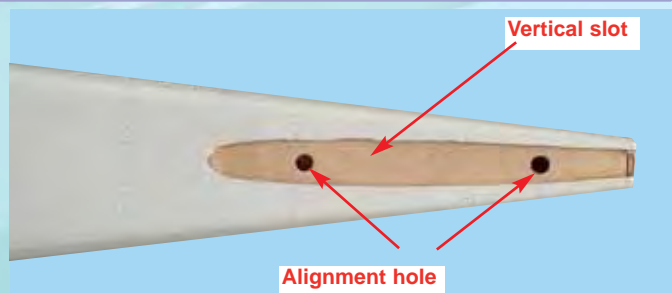

3A- Top view of the slot for the vertical stabilizer located at the aft end of the fuselage.



3B- Horizontal stabilizer with pre-installed elevator

STAGE 4

INSTALLING THE VERTICAL STABILIZER

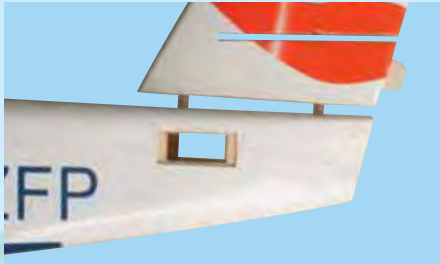

4A - Trial fit the vertical stabilizer into the slot in the fuselage.



4B - Apply sufficient 30 minute epoxy into the slot in the fuselage.



4C - Apply 30 minute epoxy to the bottom plate and dowels of the vertical stabilizer.

Step 4.1 Trial fit the vertical stabilizer into the slot in the top of the fuselage. Ensure a good clean fit and alignment. See 3A, 4A & 4D

Step 4.2 Remove the vertical stabilizer. Apply sufficient 30 minute epoxy to the slot in the fuselage and to the bottom surface and dowels of the vertical stabilizer. See 4B and 4C. Re-install the vertical stabilizer. Ensure it is fully seated into the fuselage slot and that it is aligned vertically. See 5B and 5C.

Step 4.3 Clean off any excess epoxy with a rag or tissue before it cures. See 4E.



4D - Align the vertical stabilizer so that it is straight and at right angles to the top of the fuselage.



4E- Wipe off excess 30 minute epoxy

STAGE 5

INSTALLING THE HORIZONTAL STABILIZER

Ensure that the 30 minute epoxy applied in Stage 4 is completely cured before undertaking Stage 5.

Step 5.1 Trial fit the horizontal stabilizer into its slot in the vertical stabilizer. Align carefully as shown in 5A, 5B & 5C.

Do not glue anything yet.

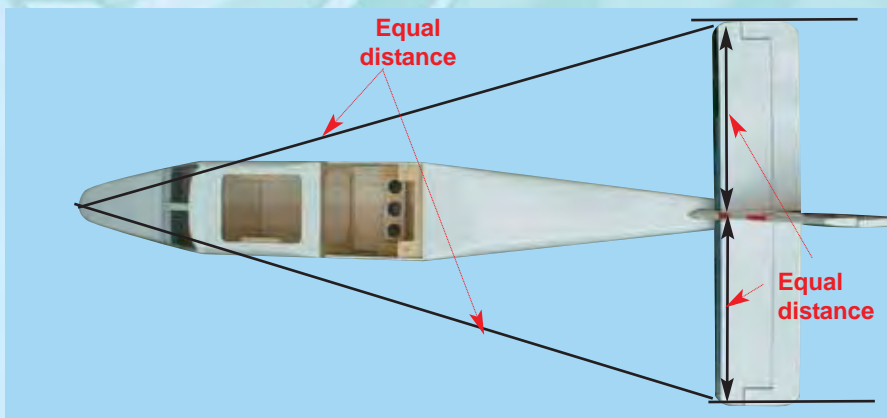

5B- Alignment of horizontal stabilizer top view



5A- Trial fit the horizontal stabilizer in its slot

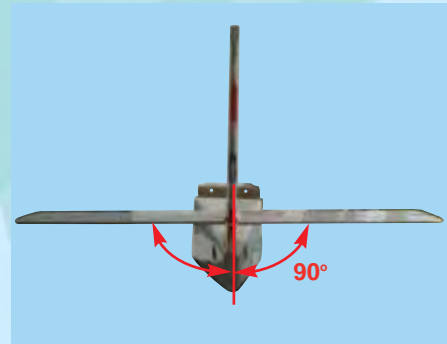

5C- Alignment back view

Step 5.2 Mark the outline of the vertical stabilizer onto the horizontal stabilizer using a non-permanent felt tip marker. See 5D & 5E..

Step 5.3 Now remove the horizontal stabilizer. Using a sharp knife & ruler CAREFULLY cut just 1/16 (1.5 mm) inside the marked lines (see 5F) and remove the covering on both sides of the horizontal stabilizer (see 5G), , making sure you only press hard enough to cut the covering, not the horizontal stabilizer.

USE CA TO FILL AND REPAIR ANY CUT MARKS IN THE WOOD.

Step 5.4 Apply sufficient 30 minute epoxy to the exposed wood areas on the top and bottom of the horizontal stabilizer and into the slot of the vertical stabilizer. Use only 30 minute epoxy. See 5H and 5I

Step 5.5 Insert the horizontal stabilizer in its slot in the vertical stabilizer and re-check the alignment as in step 5.1. See 5M

Step 5.6 Clean off any excess epoxy with a rag or tissue before it cures. See 5K.

Step 5.7 After the epoxy has completely cured, install the rudder to the vertical stabilizer using the hinges supplied. Glue hinges into place using thin CA. See 5L.

WE RECOMMEND PINNING HINGES TO LOCK THE HINGES INTO PLACE.



5D- Mark the outline of the vertical stabilizer onto the horizontal stabilizer.



5E- Mark both sides of the vertical stabilizer



5F- Carefully cut through the covering. **Do NOT cut the wood**

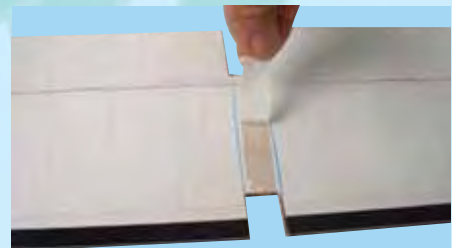

5G- Remove the covering from both sides.

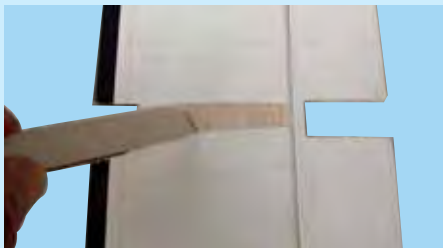

5H- Apply sufficient 30 minute epoxy to the exposed wood areas on the top and bottom of the horizontal stabilizer.



5I- Apply sufficient 30 minute epoxy into the slot of the vertical stabilizer.



5J- Insert the horizontal stabilizer into the slot.



5K- Clean off any excess epoxy with a rag or tissue before it cures.



5L- Install the rudder using the hinges supplied. Glue hinges with thin CA.

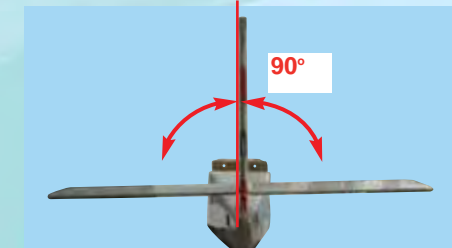

5M- 90 degree angle between the horizontal and vertical stabs

STAGE 6

INSTALLING THE LANDING GEAR

The DHC 6 Twin Otter has a trike gear configuration using main landing gear and steerable nose gear.

STAGE 7

FITTING THE MAIN LANDING GEAR

- Identify the main landing gear components shown below
- 1 pre-assembled main landing gear
 - 4 screws 10x2 [mm]

Pre-bent main landing gear

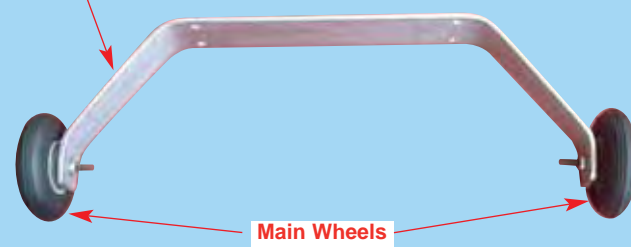

Main Wheels

7A- Main landing gear components



7B- Main landing gear location



7C- Insert the pre-bent main landing gear into the fuselage



7D- Use four 10x2 mm screws to mount the main landing gear to the fuselage

STAGE 8

INSTALLING THE NOSE GEAR

Identify the nose gear components per illustration 8A:

- 1 nose gear assembly
- 1 nose gear steering arm
- 1 nose gear steering rod with one end Z bend
- 1 EZ connector

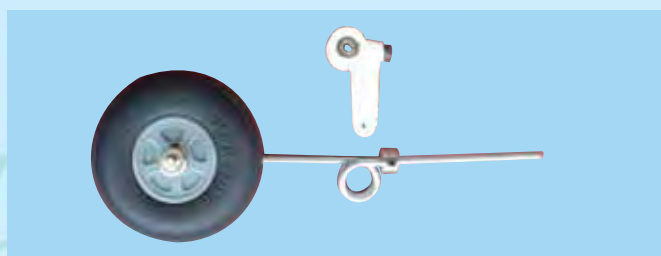

8A- Nosegear assembly



8B- Insert the steering rod Z-bend into the nose gear steering arm.



8C- Position the steering arm in the nose gear bearing.



8D - Insert the nose gear through the nose gear bearing and steering arm.



8E- Fasten the steering arm to the nose gear using an allen key to tighten the hex head set screw.



8F- Install the nose gear cover to the fuselage



8G- Install the wheel to the nose gear

STAGE 9

INSTALLING THE ELECTRIC MOTOR AND ESC

Electric motors vary in size, styles and mounting method. Items shown here are typical & for illustration purposes only. Actual appearance may vary. Always refer to the mounting instructions applicable to your motor
We illustrate the general installation procedure here utilizing the recommended VMAX 7.4-11.1V Brushless Motor

(#VMM-111B18VM) and VMAX 15 Amp Speed Control (#VMC-120B15VC).

For aftermarket purchases of the recommended VMAX motors and Electronic Speed Controls (ESC) please contact your supplier.



9A- VMAX 7.4-11.1V Brushless Motor (#VMM-111B18VM) recommended. 2 required

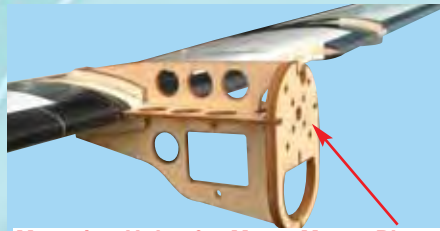

Mounting Holes for Motor Mount Plate

9B- A special pre-drilled firewall is included for mounting the recommended VMAX motor.



9C- Fasten the motor to the firewall using 4 bolts (3x10mm) & washer sets provided. Place washer on bolt and insert bolt through back of firewall & screw into tapped holes in motor mounting plate. Secure bolts with medium thread locker



Back view

9D- Back view of the motor mount

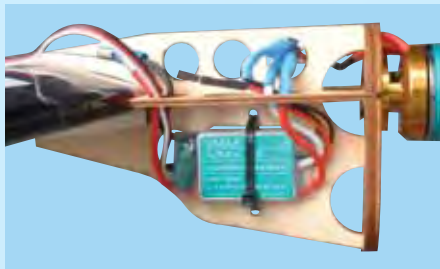

9E- Secure the Electronic Speed Control (ESC) to each motor mount using a tie wrap as shown.

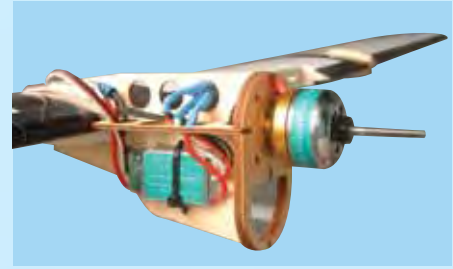

9F- Completed motor mount assembly with motor and electronic speed control installed.

CONSULT READ ME FIRST SHEET BEFORE CONNECTING COMPONENTS.

**WARNING
WRONG CONNECTIONS
WILL DESTROY COMPONENTS.**

Fuse holder/Switch. The fuse is to be inserted only when flying or testing. **ALWAYS REMOVE THE FUSE WHEN NOT FLYING OR TESTING**
TO ENSURE RELIABLE OPERATION OF YOUR MODEL, FUSE MUST BE RATED AT 30 AMPS

BEFORE PLUGGING THROTTLE CONTROL CONNECTOR INTO THROTTLE CHANNEL OF RECEIVER ENSURE PLUG IS CORRECTLY POSITIONED TO MATCH YOUR RECEIVER & SERVO WIRING.

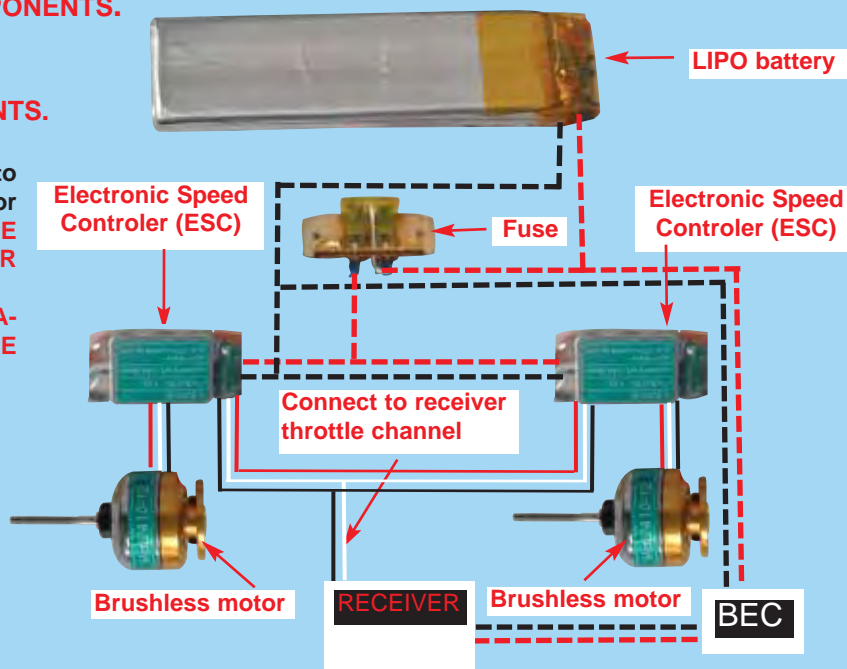

9M- Typical wiring schematic using 2 Brushless Motors plus 2 Electronic Speed Controls plus a stand alone BEC.

STAGE 10

INSTALL THE COWL AND PROPELLERS

The DHC6 TWIN OTTER has 2 engines. Test the electric power system installed in Stage 9. When you have confirmed that the motors work correctly, you are ready to install the cowls and propellers for both motors. Components

- Engine cover sets for 2 motors consisting of top cover, bottom cover & cowl for each motor. See 10A
- Dummy exhaust stacks (4). See 10G
- Transparent tape (1 roll)

Step 10.1 Work on one motor first. Attach the top motor cover (See 10A & 10B) to the top of the motor mount (See 9B) using two 2 x 8 mm screws.

Step 10.2 Attach the bottom motor cover (See 10C & 10D) to the bottom of the motor mount (See 9B) using two 2 x 8 mm screws.

Step 10.3 Install the cowl (See 10A, 10D, 10E, 10F). Ensure that the cowl is aligned with the motor and centered over the motor shaft per 10D.

Step 10.4 Use transparent tape to secure the cowl to the motor covers. See 10F

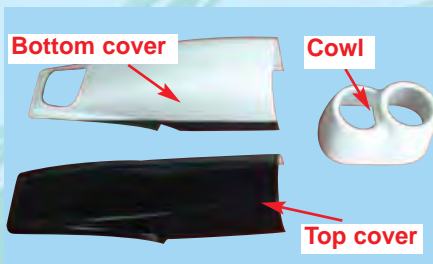

10A- Motor cover sets



10B- Attach the top motor cover

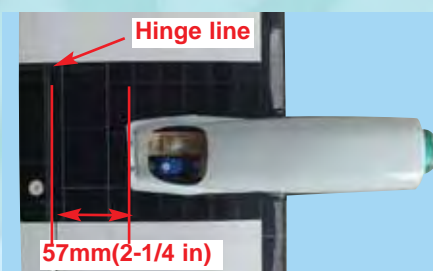

10C- Attach the bottom motor cover



10D- Position the cowl over the engine covers. Align cowl & center about the motor shaft.



10E- Side view of cowl installed with the motor covers.



10F- Use transparent tape to secure the cowl to the motor covers.

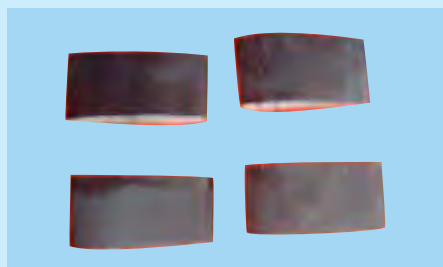

10G- 4 dummy exhaust stacks



10H- Use CA glue to attach the dummy exhaust stacks to the cowl.



10I- Install the propeller and spinner

Step 10.5 Use CA glue to attach the dummy exhaust stacks to the cowl. See 10G & 10H.

Step 10.6 With the **BATTERY & FUSE REMOVED** securely install the propeller. Double check your work and ensure that the propeller is securely attached and will not come off.

Step 10.7 Repeat steps 10.1 to 10.6 for the second motor.

STAGE 11

FITTING THE ELEVATOR AND RUDDER CONTROL HORNS

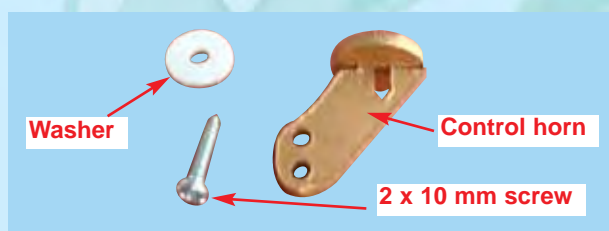

11A- Control horn assembly for aileron and elevator with 2 x 10 mm screw and washer

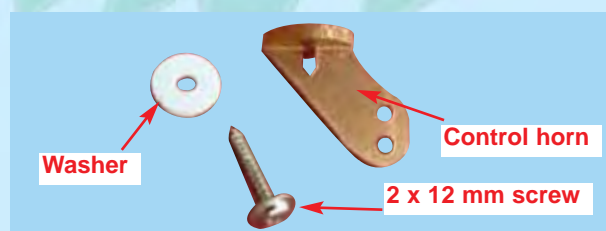

11B- Control horn assembly for rudder with 2 x 12 mm screw and washer

Laser cut lexan control horns for the aileron & elevator use a 2 x 10 mm screw. See 11A. The control horn for the rudder uses a 2 x 12 mm screw. See 11B.

Install the control horns using 30 minute epoxy and the appropriate screw. See 11C.

Install the control horns as shown in 11D, 11E, 11F and 11G.

Wipe away excess epoxy before it cures.

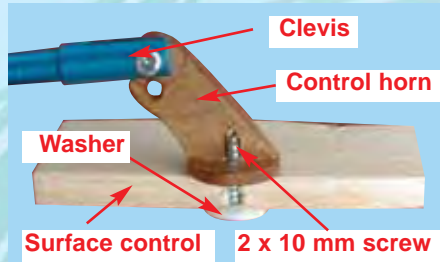

11C- Typical installation of laser cut lexan control horn assembly.



11D- Elevator control horn location



11E- Install the elevator control horn using 30 minute epoxy, washer and 2 x 10 mm screw.



11F - Install the rudder control horn using 30 minute epoxy, washer and 2 x 12 mm screw



11G- Using 30 minute epoxy install the rudder control horn to its location in the rudder

STAGE 12

INSTALLING THE RUDDER AND ELEVATOR SERVOS

Select two suitable micro servos and install the rubber servo grommets & brass ferrules supplied with your servos. The two servos that control the elevator and rudder are to be installed in the servo tray located in the fuselage.

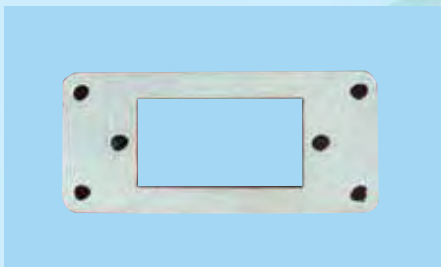

12A - Servo tray. 1 for Rudder servo. 1 for Elevator servo.



12B - Servo mounted to BACK SIDE of servo tray.



12C- Rudder servo location



12D- Elevator servo location



12E - Elevator servo attached to the fuselage and connected to the elevator control horn.

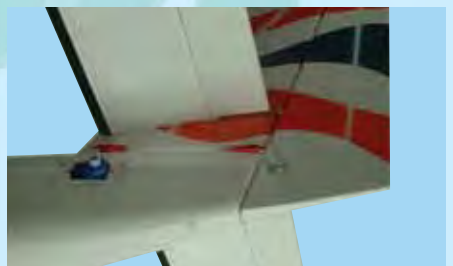

12F - Rudder servo attached to the fuselage and connected to the rudder-control horn.

STAGE 13

INSTALLING THE AILERON CONTROL SYSTEM

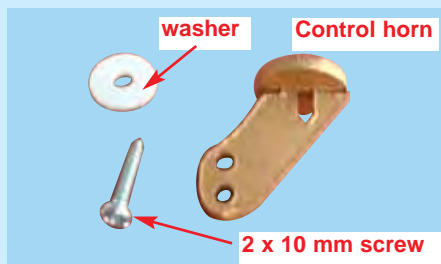

13A- Typical lasercut control horn assembly



13B- Aileron control horn location

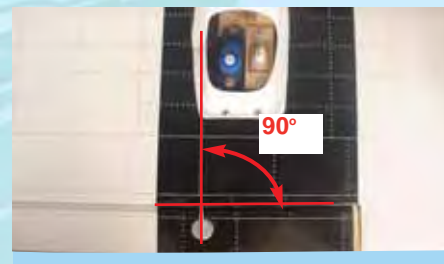

13C- Aileron control horn position



13D - Install the aileron control horn using 30 minute epoxy and the washer with 2 x 10 mm screw.



13E- Connect the aileron control rod between the servo arm and the control horn

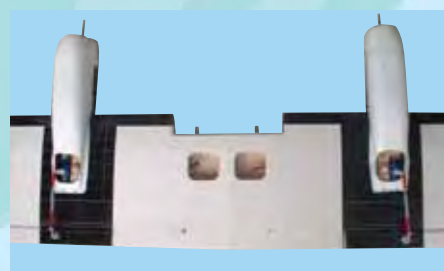

13F - Both aileron controls installed.

To install the aileron servos into the wing you will need the following items:

- 2 micro servos
- Servo mounting screws and grommets as supplied with the servos
- Servo control arms as supplied with the servos
- Two aileron control rod assemblies supplied with the kit. The assemblies consist of a rod with a clevis screwed onto both ends
- Low tack masking tape
- 2 aileron control horn assemblies

Ensure Stage 10 has been completed before continuing.

Step 13.1 Turn the wing upside down. Install one servo first, then the second servo.

Step 13.2 Trial fit the aileron servo into the servo mounting cavity. You may have to modify the cavity slightly to provide clearance for the servo and servo wires.

Step 13.3 Use a hobby knife to modify the cavity as required. Most servos have their output shaft closer to one end than the other. Mount the servo so that the output shaft is closer to the trailing edge of the wing.

Step 13.4 Screw the servo into place with the screws and grommets supplied. It is important to install the grommets and screws correctly. See the manual that came with your servos for instructions about your particular servo grommets.

Step 13.5 Fasten the screws down according to the servo manufacturers recommended tightness.

Step 13.6 Repeat steps 13.2 to 13.5 for the second aileron servo.

STAGE 14

ADJUST CONTROL SURFACE THROW LIMITS

Adjust the deflection of the control surfaces to match the specifications on page 12. You can reduce the amount of throw by doing either or both of the following:

- From the servo end, move the clevis to a hole in the servo arm that is closer to the servo output shaft.

- From the control horn end, move the control rod/clevis further out on the horn (away from the control surface). Always confirm that the clevis is firmly attached after making any adjustment.

STAGE 15 FINAL RC SET-UP

Before starting the final set-up of the model, switch on the radio and ensure that all trims are in their neutral positions. Check that the ailerons, elevator and rudder are centered. If any adjustments are needed, do these by uncoupling the relevant clevis and turning it clockwise to shorten the linkage or counter-clockwise to lengthen it. Only when each control surface has been centered mechanically in this way should you begin adjusting the surface movement (or throw)

Now confirm that the control surfaces are moving in the correct direction. Use the servo reversing switches on your transmitter to reverse the direction of a servo if necessary. The most popular transmitter mode (with the throttle on the left, with ailerons and elevator on the right) is shown here.

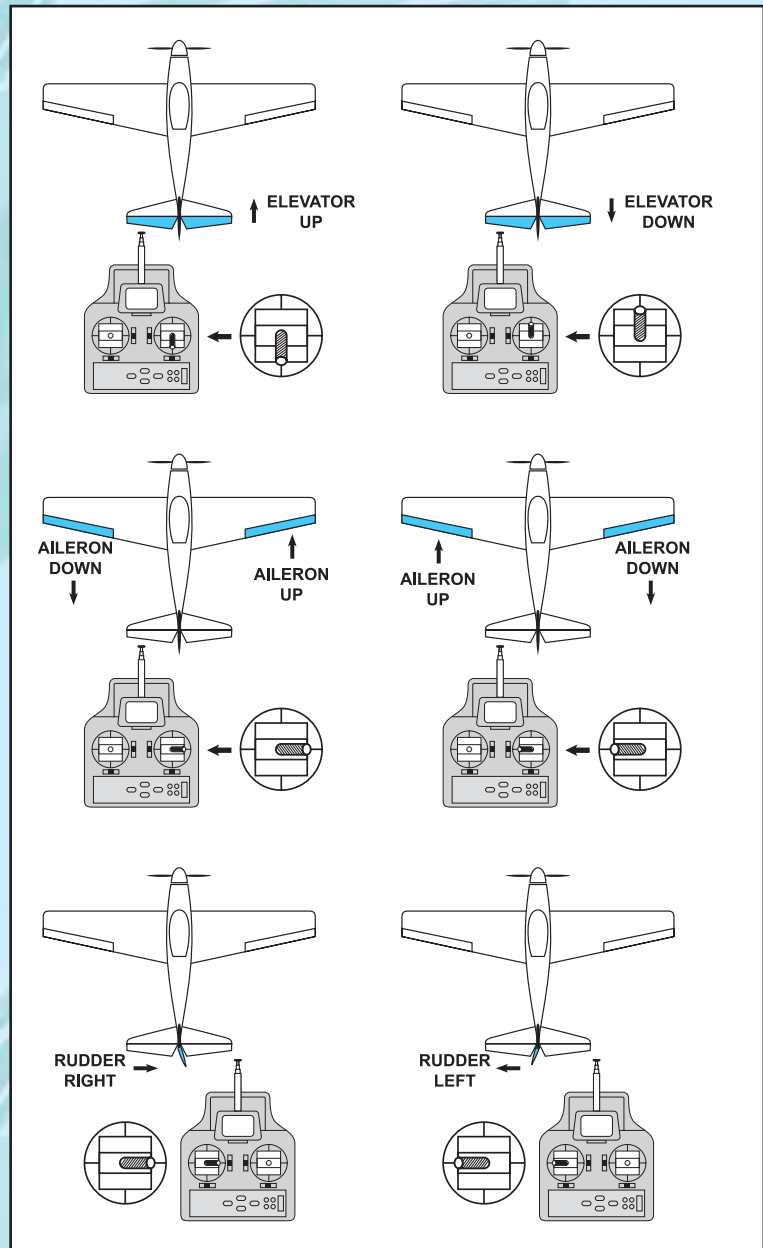

STAGE 16 INSTALLING THE RECEIVER

Step 16.1 Consult your radio manual for instructions about hooking up your receiver.

Step 16.2 Plan where you are going to put the receiver with consideration for routing the antenna safely.

Step 16.3 Wrap the receiver securely in foam suitable for RC equipment and wrap the foam insulated receiver in a

plastic bag or cling wrap.

Step 16.4 Generally in the absence of specific instructions from the radio manufacturer, it is recommended that the receiver should be placed where it is least likely to have impact during a crash. Keep the battery pack and other heavy loose items ahead of the receiver.

STAGE 17 CONFIRM RADIO OPERATION

Carefully review how your Electronic Speed Controls (ESC) work. Most ESC's will not power up a motor until the throttle has been reduced to zero. Avoid both props in case either or both of the two motors suddenly start to turn.

Step 17.1 Consult your radio manual for instructions about testing and operating your radio system.

Step 17.2 Pay particular attention to charging your batter-

ies and range testing your system before and after each flight.

Step 17.3 Check that all controls are working correctly before and after each flight.

FOR ELECTRIC POWER, YOU WILL NEED TO INSTALL THE FUSE AND YOUR BATTERY TO TEST THE ESC'S AND THE MOTORS.

STAGE 18 BALANCING THE AIRCRAFT

Step 18.1 The CG for your DHC6 Twin Otter is located at 2" to 2-1/8" (50 - 55 mm) back from the leading edge of the wing when the wing has been attached to the fuselage as per illustration 19A.

Step 18.2 For the initial flight, the CG should be located at 2" (50mm) back from the leading edge of the wing when the wing has been attached to the fuselage.

Step 18.3 The CG is measured with the motor, battery and all other components installed.

Step 18.4 Set up the CG as it will be when you fly it.

Step 18.5 It is very important to have the CG correct. Flying your model with the CG too far back will likely lead to loss of control and a crash. If you discover that after you have assembled your model and installed your radio, motor and battery that the CG of your model is incorrect you must bring the CG to the correct location by doing the following BEFORE FLYING :

- Move the battery pack fore or aft
- Do not add weight to correct the CG. Move components & especially your battery pack rather than add weight. Only add weight as a measure of last resort.

STAGE 19 CONFIRM MECHANICAL INTEGRITY

Step 19.1 Once you have confirmed that the CG is correct, you should do a thorough review of the entire model before your first flight. Check everything twice! Every hook up, every coupling, everything! Do it twice!!

Step 19.2 Before your first flight, have an experienced flyer review your work. Do not fly your model until it has been checked out by a third party who knows how to fly and how to set up a model aircraft. Do not fly alone. Seek experienced help.

Step 19.3 Once you have completed your first flight, get in the habit of checking your model over before and after each flight! Don't fly if you find something that is not right!

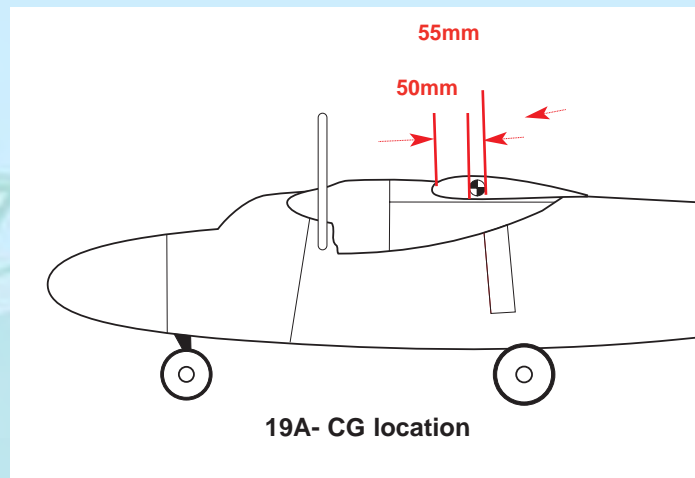

CONTROL SURFACE THROW SPECIFICATIONS:

The throws are measured at the widest part of the control surface. Adjust the position of the pushrods at the control and/or servo horns to control the amount of throw. You may

also use ATV's if you radio has them but the mechanical linkages should still be set so that the ATV's are near 100% for best servo resolution.



Low rate

ELEVATOR 1/6" (4mm) up
1/6" (4mm) down

AILERON 1/6" (4 mm) up
1/6" (4 mm) down

RUDDER 1/3" (8 mm) right
1/3" (8 mm) left

High rate

1/4" (6 mm) up
1/4" (6 mm) down

1/4" (6 mm) up
1/4" (6 mm) down

2/5" (10 mm) right
2/5" (10 mm) left

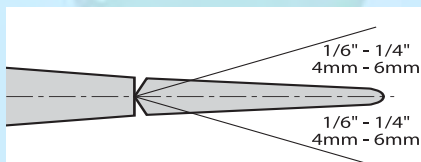

Elevator

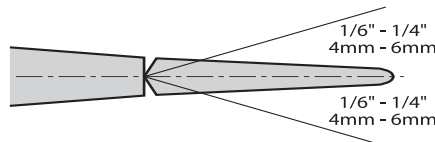

Aileron

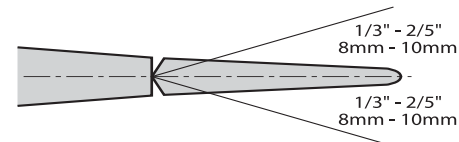

Rudder

STAGE 20

BATTERY INSTALLATION

Install the battery by securing the battery to the battery platform:

Step 20.1 Remove the battery hatch (see 20A).

Step 20.2 **REMOVE THE FUSE and STAY CLEAR OF THE PROPELLERS AT ALL TIMES.**

Step 20.3. Connect the battery to the Electronic Speed Controls. We recommend using a Lithium Polymer (LiPo) battery.

Step 20.4 Place the battery on the battery platform (see 20B, 20C & 20E). If the battery moves it will shift the CG location and/or possibly unplug itself causing loss of control.

Step 20.5 Secure the battery in place on the platform using Velcro straps &/or foam padding so that the battery cannot move. **DO NOT FLY WITH A LOOSE BATTERY.**

Step 20.6 Re-install the battery hatch. See 20D



20A- Battery hatch

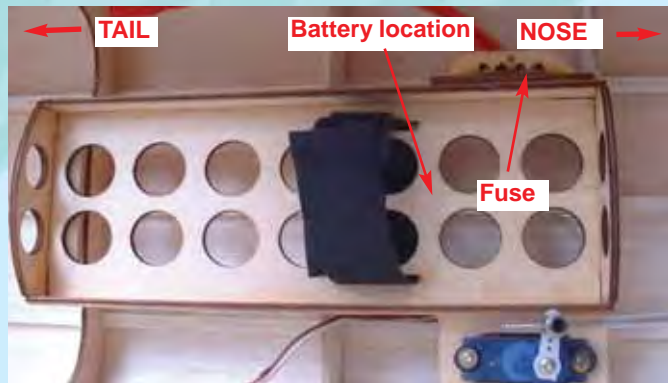

20B- Battery platform

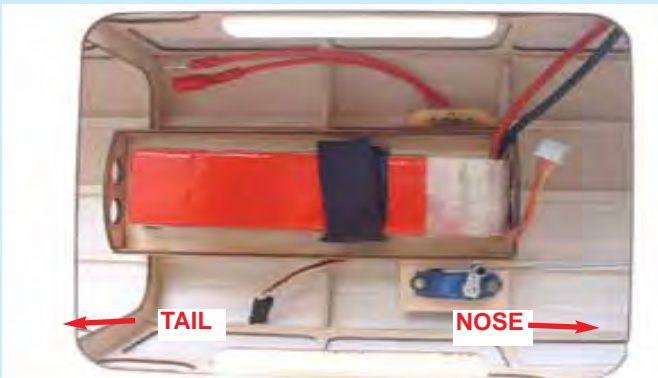

20C- Battery installed



20D- Battery hatch installed

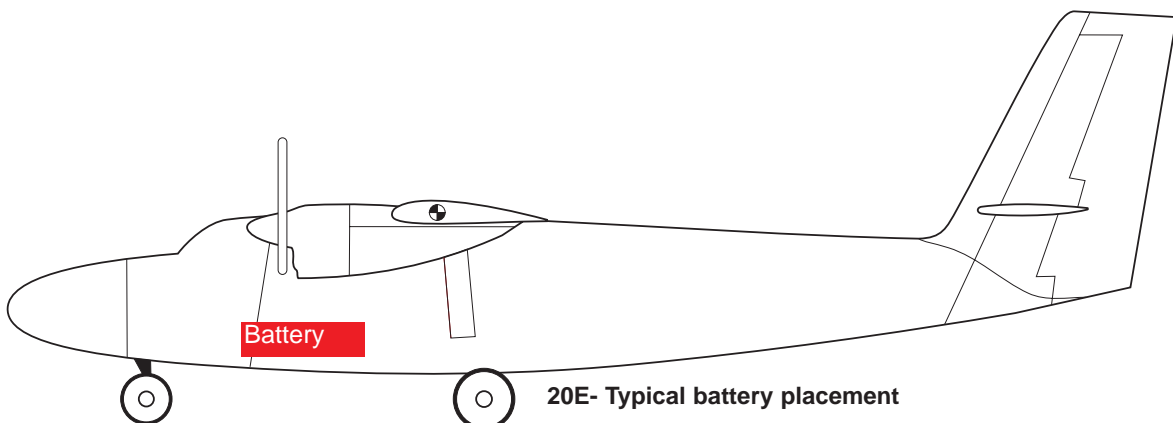

20E- Typical battery placement

STAGE 21

CONNECTING THE NOSE GEAR STEERING ROD

Ensure Stage 8 and 20 has been completed before continuing. Remove battery hatch.

Step 21.1 Connect the nose gear steering rod to the steering arm.

Step 21.2 Connect the nose gear steering rod to the servo arm.



21.1 Nose steering arm connect to the steering rod



21.2 Nose steering rod connect to the nose steering servo arm

STAGE 22

INSTALLING THE WING STRUTS

THE WING STRUTS MUST BE CORRECTLY INSTALLED AND REMAIN SECURELY ATTACHED AT ALL TIMES DURING FLIGHT. THE WING WILL FAIL IF FLOWN WITHOUT THE STRUTS.

To install the wing struts you will need the following items:

- Left and right wing struts (See 22A)
- Two 2 x 10 mm screws and two plastic washers
- Two 3 mm nuts with two plastic washers

Step 22.1 Review 2A and 2B. Ensure that the wing strut anchors and aileron servos have been installed as per Stage 2. Securely install the wing struts as illustrated below. See 22A - 22F inclusive.



22A- Wing struts

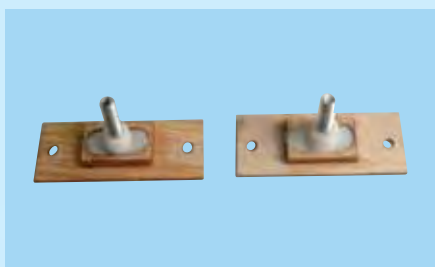

22B- Wing strut anchors



22C- Wing strut anchor installed in the left wing



22D- Wing strut anchor installed in the right wing

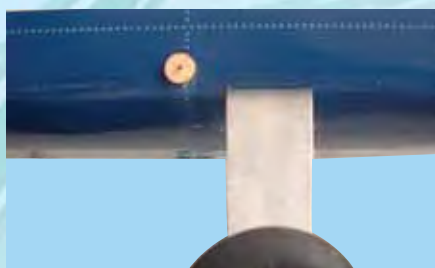

22E- Wing strut anchor point on the fuselage



22F- Typical installed wing strut.



DHC-6 TWIN OTTER WITH WING STRUTS INSTALLED

OTHER VMAR ELECTRIC POWERED ARF MODELS
FOR INFORMATION ABOUT THESE & OTHER
VMAR PRODUCTS PLEASE VISIT US AT...
www.richmondrc.com



BIRDDOG L19 USAF VERSION
Order Ref Item #VMA-B210U



BIRDDOG L19 US.ARMY VERSION
Order Ref item #VMA-B210A



AERO SUBARU BLUE
Order Ref item #VMA-S210B



AERO SUBARU RED
Order Ref item #VMA-S210R





PIPER CUB J3 YELLOW
Order Ref item #VMA-C210Y



PIPER CUB L4 military
Order Ref item #VMA-C210D



PC9 Roulette
Order Ref item #VMA-P210A

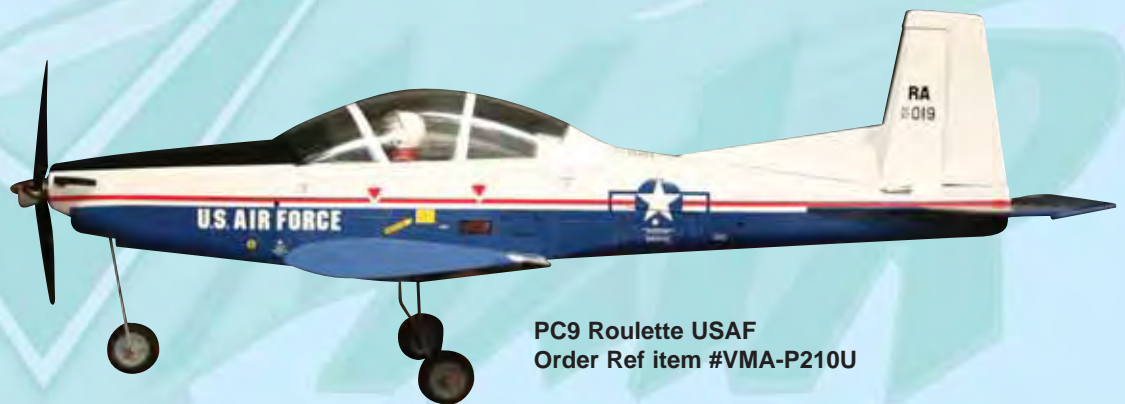

PC9 Roulette USAF
Order Ref item #VMA-P210U



**VMAR, POLYCOTE and VMAX are Trademarks of VMAR Manufacturing Inc. and appointed VMAR agents worldwide.
Copyright VMAR Manufacturing Inc. #VMA-T210XIB 20061031**