

DO 27 ELECTRICS



ASSEMBLY & OPERATIONS MANUAL

Please review this manual thoroughly before assembling or operating this model.

Proceeding with assembly and use of this product indicates Agreement With & Acceptance of the following Liability Disclaimer.

Model airplanes, model engines, model engine fuel, propellers and related accessories, tools and equipment can be hazardous if improperly used. Be cautious and follow all safety recommendations when using your VMAR model airplane. Keep hands, tools, clothing and all foreign objects well clear of engines when they are operating. Take particular care to safeguard and protect your eyes and fingers and the eyes and fingers of other persons who may be nearby. Use only a good quality propeller that has no cracks or flaws. Stay clear of the propeller and stay clear of the plane of rotation defined by the propeller. The Manufacturer, Distributor, Retailer and/or other

suppliers of this product expressly disclaim any warranties or representations, either expressed or implied, including but not limited to implied warranties of fitness for the purposes of achieving and sustaining remotely controlled flight. In no event will the Manufacturer, Distributor, Retailer and/or other suppliers of this product have any obligation arising from contract or tort, or for loss of revenue or profit, or for indirect, special, incidental, consequential or other damages arising from the use of this product. In purchasing and/or using this product, the user accepts all responsibility for its use and accepts all liability associated with such use.

CAUTION

A Remote Control Model Aircraft is not a toy. It is a flying model that functions much like a full size airplane. If you do not assemble and operate this product properly you can cause injury to yourself and others and damage property. **DO NOT FLY** this model if you are not qualified. You are entirely responsible for the mechanical,

aeronautical and electrical integrity of this model and it's structure, control surfaces, hinges, linkages, covering, engine, radio, wiring, battery and all other components. Check all components before and after each flight.

Don't fly until it's right!



POLYCOTE™ ECS
ENHANCED COVERING SYSTEM



The Graphics and Detailing are inside the POLYCOTE ECS!

STAGE 1

INSTALLING THE AILERON CONTROL HORNS

Step 1.1 Turn the wing upside down and locate the pre-drilled control horn holes. See 1B

Step 1.2 Trial fit the laser cut control horn assembly (See 1A) into the aileron. See 1B, 1C, 1D

Step 1.3 Use plenty of 30 minute epoxy to glue the aileron

control horns to the right and left wings as shown in 1B, 1C and 1D.

Step 1.4 Wick thin CA such as Pacer ZAP (Pink) into the plywood of the control horn to "harden" the plywood and holes. Do two applications 1 minute apart.



1A- Aileron control horn



1B- Aileron control horn location

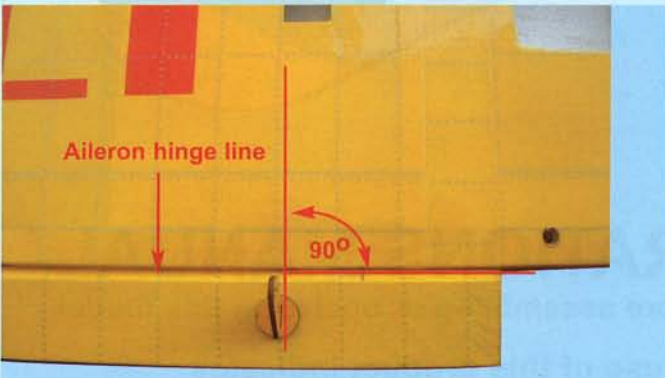

1C- Trial fit aileron control horn to the aileron



1D- Control horn installation to the aileron

STAGE 2

INSTALLING THE AILERON SERVOS INTO THE WING

To install the aileron servos into the wing you will need the following items:

- 2 micro servos
- Servo mounting screws and grommets as supplied with the servos
- Servo control arms as supplied with the servos
- Two aileron control rod assemblies supplied with the kit. The assemblies consist of a rod with a clevis screwed onto both ends
- Low tack masking tape
- 2 aileron control horn assemblies

Step 2.1 Turn the wing upside down. Install one servo first, then the second servo.

Step 2.2 Trial fit the aileron servo into the servo mounting cavity. You may have to modify the cavity slightly to provide clearance for the servo and servo wires.

Step 2.3 Use a hobby knife to modify the cavity as required. Most servos have their output shaft closer to one end than the other. Mount the servo so that the output shaft is closer to the leading edge of the wing.

Step 2.4 Screw the servo into place with the screws and grommets supplied. It is important to install the grommets and screws correctly. See the manual that came with your radio for instructions about your particular servo grommets.

Step 2.5 Fasten the screws down according to the servo manufacturers recommended tightness.

Step 2.6 Repeat steps 2.2 to 2.5 for the second aileron servo.



2A- Prepare the servos by fitting the rubber grommets & ferrules supplied with your servos



2B- Typical aileron servo location

STAGE 3

INSTALLING THE AILERON CONTROL SYSTEM

Step 3.1 Consult your radio instruction manual and center the aileron servos using either a Y connector or a computer radio that accommodates the use of two aileron servos.

Turn on the transmitter and then the receiver. Center the aileron trim lever on the transmitter. Remove the servo arm mounting screws and servo arms.

Step 3.2 Mount the servo arms back on the servos so that the servo arms are parallel with the back edge of the wing. Screw the arms into place using the servo arm mounting screws supplied with the servos.

Step 3.3 Locate the two aileron control rods in the hardware bag (see 3A). Ensure the clevises are screwed well onto the threaded portion of the rod. Rotate and tug aggressively on the clevises and ensure that they are not loose on the rods.

Step 3.4 Tape the ailerons into their neutral position so that they are even with the trailing edge of the wing and not pointing either up or down.

Step 3.5 Review 3B and 3C to ensure the control rod assemblies align correctly between the servo arms and the control horns.

Step 3.6 Connect the aileron servo control rods between

the aileron control horns and the aileron servo arms as shown in 3C.

Step 3.7 Carefully remove the masking tape holding the ailerons.

Step 3.8 Turn on your radio and activate the ailerons, using the aileron stick and ensure that a smooth full motion can be achieved.

Step 3.9 With the wing top side up and viewed from the back, ensure that moving the transmitter aileron stick to the left raises the left aileron and lowers the right aileron. Movement of the stick to the left will roll the aircraft to the left. (Counterclockwise roll of the wing when viewed from the back).

Step 3.10 With the wing top side up and viewed from the back, ensure that moving the transmitter aileron stick to the right raises the right aileron and lowers the left aileron. Movement of the stick to the right will roll the aircraft to the right. (Clockwise roll of the wing when viewed from the back).



3A- Aileron control rod assembly



3B- Aileron control horn after installation.



3C-Connect the aileron control rod between the servo arm and the control horn

STAGE 4

FITTING THE HORIZONTAL AND VERTICAL STABILIZERS

To install the stabilizers into the fuselage you will need:

- Fuselage
- Vertical stabilizer with pre-installed rudder
- Horizontal stabilizer with pre-installed elevator

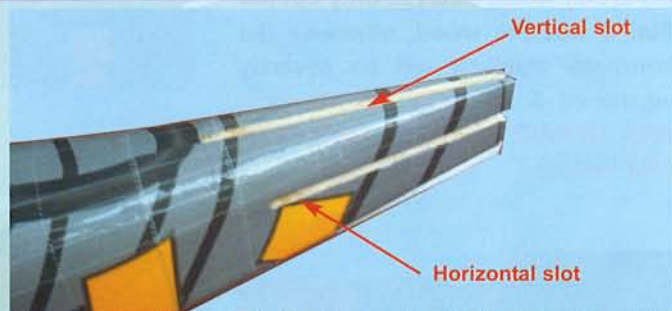

4A- The fuselage slots for the vertical & horizontal stabilizers

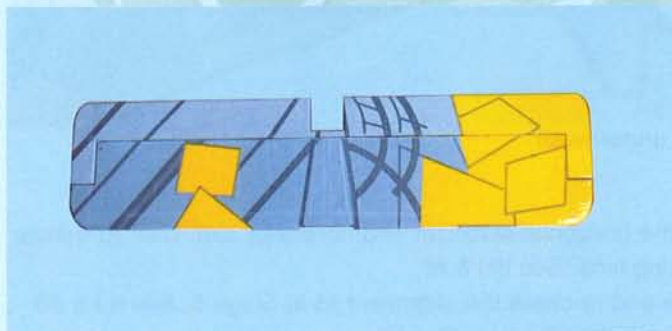

4B- Horizontal stabilizer with pre-installed elevator



4C- Vertical stabilizer with pre-installed rudder

STAGE 5

ALIGNMENT OF HORIZONTAL STABILIZER

Check the fit of the horizontal stabilizer in its slot. Make sure the horizontal stabilizer is square and centered to the fuselage by taking measurements as shown in pictures 5A, 5B and 5C.

Do not glue anything yet.

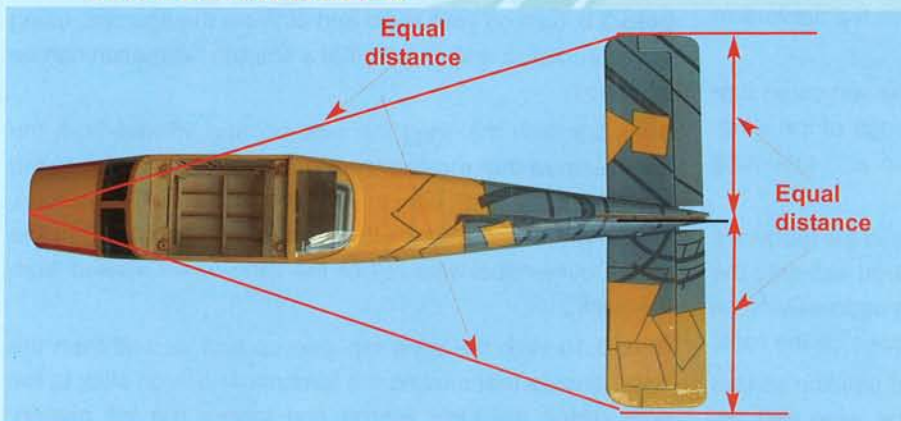

5B- Alignment of horizontal stabilizer top view



5A- Trial fit the horizontal stabilizer in its slot

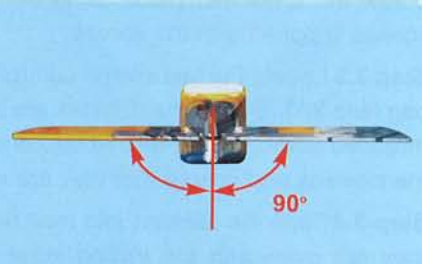

5C- Alignment back view

STAGE 6

INSTALLING THE HORIZONTAL STABILIZER

Step 6.1 With the horizontal stabilizer aligned correctly, mark the shape of the fuselage on the top & bottom of the horizontal stabilizer using a water soluble non-permanent felt-tip pen as shown here. See 6A, 6B, 6C



6A- Mark the top of the horizontal stabilizer...



6B- ...and the bottom

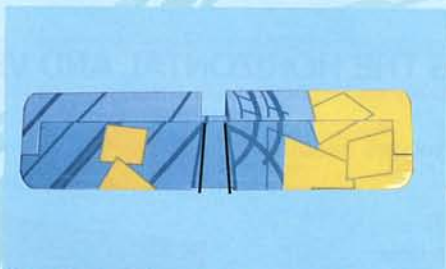

6C- Marked lines on horizontal stab



6D- Cutting inside the lines. **Do NOT cut the wood**

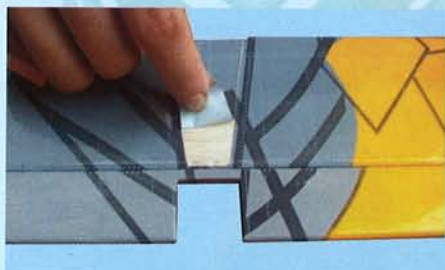

6E- Remove the covering from top surface

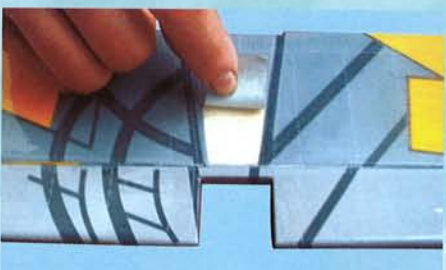

6F- Exactly the same underneath



6G- Clean off the pen lines

Step 6.3 Now apply sufficient epoxy to the top and bottom of the horizontal stabilizer and horizontal slot. Use 30 minute epoxy to ensure a strong bond and give yourself plenty of working time. See 6H & 6I

Step 6.4 Insert the horizontal stabilizer in its slot in the fuselage and re-check the alignment as in Stage 5. See 6J & 5B

Step 6.5 Excess epoxy should be cleaned off with a rag or tissue before it cures. See 6K



6H- Apply plenty of 30 minute epoxy into the horizontal slot



6I- Apply plenty of 30 minute epoxy to the horizontal stabilizer

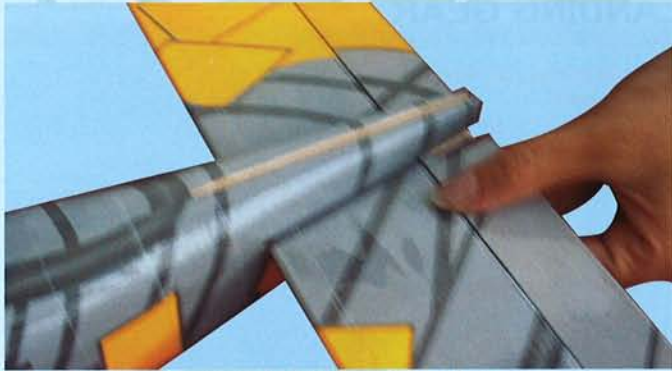

6J- Slide the horizontal stabilizer into place

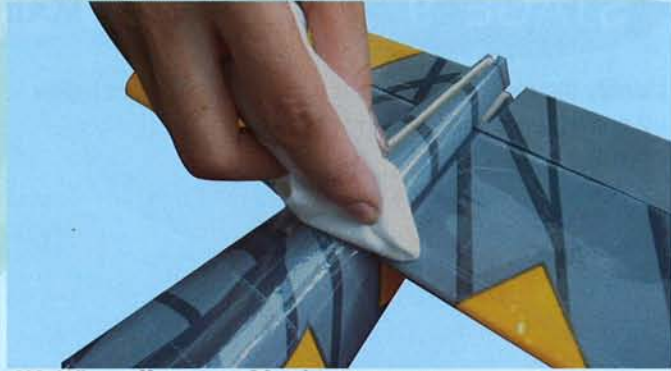

6K- Wipe off excess 30 minute epoxy

STAGE 7 FITTING THE VERTICAL STABILIZER

Step 7.1 Check the fit of the vertical stabilizer in its slot. Make sure that it is square to the horizontal stabilizer and fuselage. See 7A and 7G

Step 7.2 Mark the shape of the fuselage on the left & right sides of the vertical stabilizer using a felt-tip pen. See 7B

Step 7.3 Now remove the vertical stabilizer. Using a sharp knife & ruler CAREFULLY cut just 1/8" (3mm) inside the marked lines (see 7C) and remove the covering on both sides of the fin (see 7D), just as you did with the horizontal stabilizer, making sure you only press hard enough to cut the covering, not the vertical stabilizer. **USE CA TO FILL AND REPAIR ANY CUT MARKS IN THE WOOD.**



7A- Trial fit the vertical stabilizer into the fuselage slot



7B- Mark both sides of the vertical stabilizer



7C- Carefully cut through the covering. **Do NOT cut the wood**



7D- Remove covering from both sides

Step 7.4 Now apply sufficient epoxy to both sides & the bottom of the vertical stabilizer as illustrated in 7E. Use 30 minute epoxy to ensure a strong bond and give yourself plenty of working time.

Step 7.5 Insert the vertical stabilizer in its slot in the fuselage and re-check the alignment. Excess adhesive should be cleaned off with a rag or tissue before it cures.



7E- Apply plenty of 30 minute epoxy



7F- Slide the stab into place & remove excess epoxy

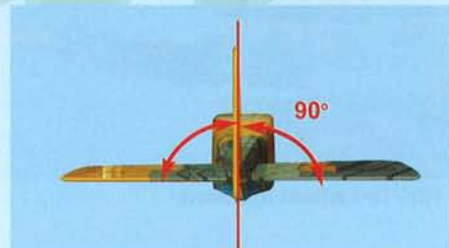

7G- 90 degree angle between the horizontal and vertical stabs.

STAGE 8

INSTALLING THE LANDING GEAR

The DO 27 has a tail dragger configuration using main landing gear and steerable tail wheel.



STAGE 9

FITTING THE MAIN LANDING GEAR

Identify the main landing gear components shown below

- 2 pre-assembled main landing gear
- 4, 10x2 [mm] screws
- 2 plastic landing gear straps

Pre-bent main landing gear wires

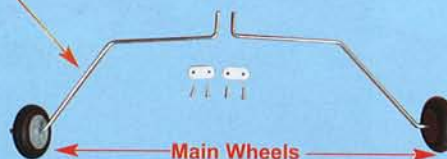

9A- Main landing gear components



9B- Main landing gear location



9C- Insert the pre-bent main landing gear into the fuselage



9D- Use two straps and four 10x2 [mm] screws to mount main landing gear assembly to the fuselage

STAGE 10

INSTALLING THE TAIL WHEEL

Identify the nose gear components per illustration 10A:

- 1 tail wheel assembly
- 2, 2x10 [mm] screws



10A- Tail wheel assembly

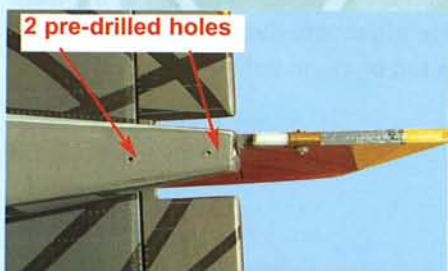

10B- Tail wheel location



10C- Insert the tail wheel to the sleeve tube



10D- Use two 2x10 mm screws to install the tail wheel assembly to the fuselage

STAGE 11

INSTALLING THE ELECTRIC MOTOR AND ESC

Electric motors vary in size, styles and mounting method. Items shown here are typical & for illustration purposes only. Actual appearance may vary. Always refer to the mounting instructions applicable to your motor.

We illustrate the general installation procedure here utilizing the recommended VMAX Brushless Motor (#VMM-111B18VM) and VMAX 15 Amp Speed Control with BEC

(#VMC-120B15VC).

If you have purchased a pre-assembled VMAX power module assembly consisting of firewall, motor and speed control you may skip 11A through 11E.

For aftermarket purchases of the VMAX power module assembly please contact your supplier.

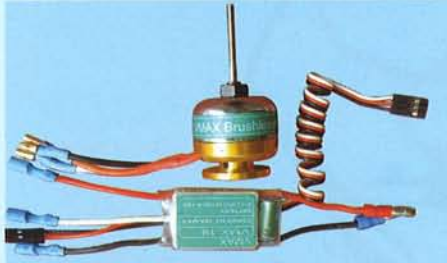

11A- VMAX Brushless Motor (#VMM-111B18VM) recommended



11B- A special pre-drilled firewall is included for mounting the recommended VMAX motor. A blank firewall is also provided for other motor installations



11C- Install the motor to the firewall using 4 bolts (3x10mm) & washer sets provided. Place washer on bolt and insert bolt through back of firewall & screw into tapped holes in motor mounting plate. Secure bolts with medium thread locker

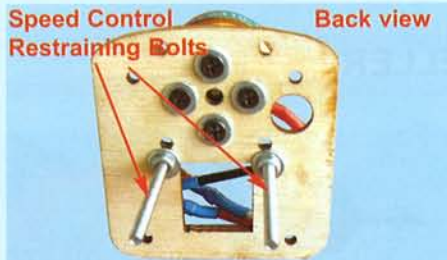

11D- Install the two long speed control restraining bolts so that they protrude from the back of the firewall as shown

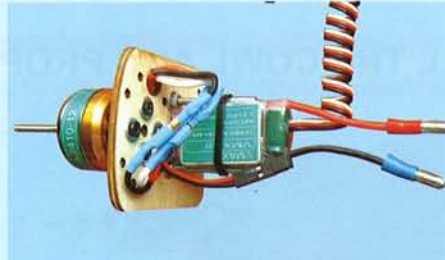

11E- Secure the Electronic Speed Control to the restraining bolts using a tie wrap as shown



11F- Completed power module assembly with motor and electronic speed control installed



11G- Fuse location



11H- Mount the pre-assembled fuse holder/switch to the fuselage by using two 2x8 [mm] screws



11I- Test fit a 20 Amp automotive spade fuse into the fuse holder/switch and then **REMOVE THE FUSE**

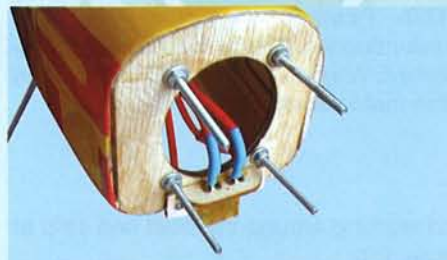

11J- Install four 3x30 [mm] bolt sets (supplied). Bolt-washer-former-washer-nut (front). Tighten the nuts securely & apply thread locker

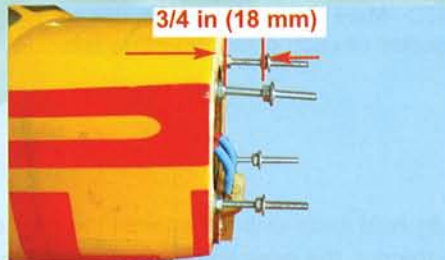

11K- Thread four 3 mm nuts onto the bolts as shown. The nuts should all be evenly spaced at 3/4 in. (18 mm) from the firewall



11L- Place four 3 mm washers on the bolts & then position the assembled power module. Secure in place with four more 3 mm washers & nuts. Tighten snugly

WARNING
WRONG CONNECTIONS
WILL DESTROY COMPONENTS.

Fuse holder/Switch. The fuse is to be inserted only when flying or testing. **ALWAYS REMOVE THE FUSE WHEN NOT FLYING OR TESTING** TO ENSURE RELIABLE OPERATION OF YOUR MODEL, FUSE MUST BE RATED AT 20 AMPS

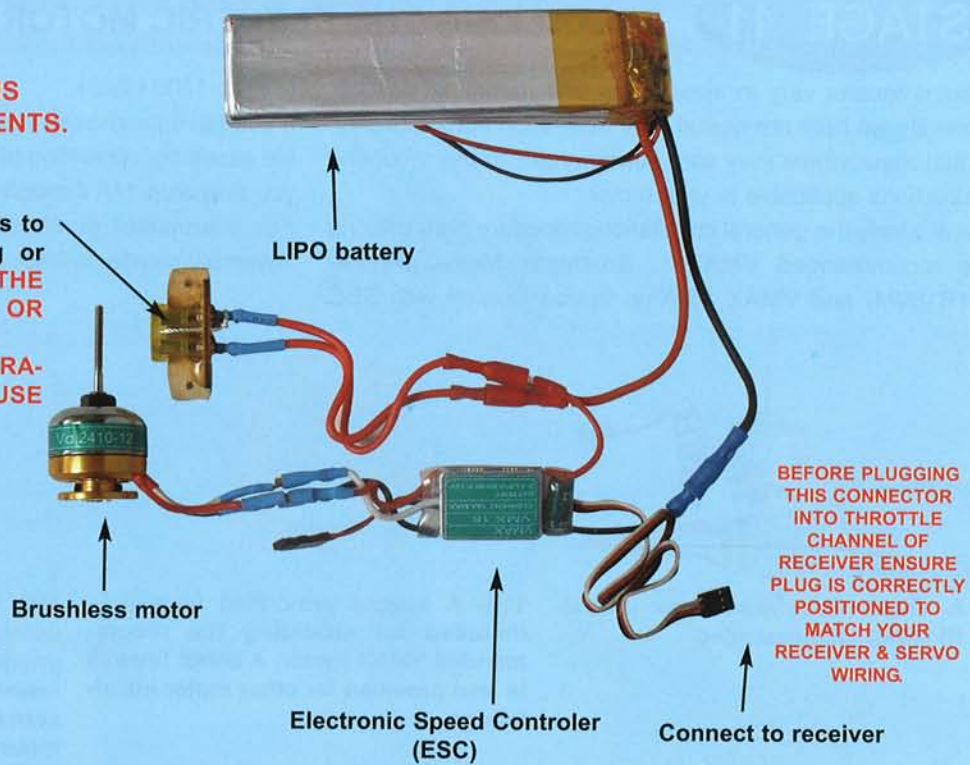

11M- Typical wiring diagram of brushless motor system

STAGE 12 INSTALL THE COWL AND PROPELLER

Install and align the cowl using the four cowl mounting screws provided. The screws pass through the sides of the cowl and into the tabs on the front of the fuselage.

Step 12.1 Cut card stock strips about 1/2 x 5" (12x120 mm). Use low tack masking tape to position the strips as shown in 12A & 12B.

Note that the tape is applied towards the rear of the strips and that the front of the strips overlap the cowl mounting tabs at the front of the fuselage.

Step 12.2 Mark each strip with a dot in the center of each cowl mounting tab as shown in 12C.

Step 12.3 Slide the cowl into place to completely cover the mounting tabs on the fuselage & such that the strips are outboard of the cowl as shown in 12D. Align the cowl so that the motor shaft is centered.

Secure the cowl in position with low tack masking tape.

Step 12.4 Without moving the cowl, carefully hold each strip flat against the cowl and working around the cowl one strip at a time, drill a 5/64 in. (2 mm) hole through the dot, the cowl and the mounting tab. See 12E

Step 12.5 Hold the cowl in place using four 2x10 [mm] screws. Carefully remove the strips and all masking tape.

Step 12.6 With the **BATTERY & FUSE REMOVED** securely install the propeller. Double check your work and ensure that the propeller is securely attached and will not come off.



12A- Card stock strips overlying the cowl mounting tabs on the right side of the fuselage

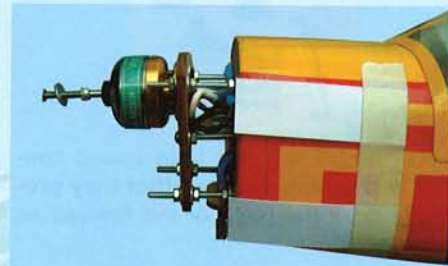

12B- Card stock strips overlying the cowl mounting tabs on the left side of the fuselage



12C- Mark the strip with a dot at the center of each cowl mounting tab



12D- Position the cowl over the mounting tabs. Note the strips are outboard. Align & center with respect to the motor shaft

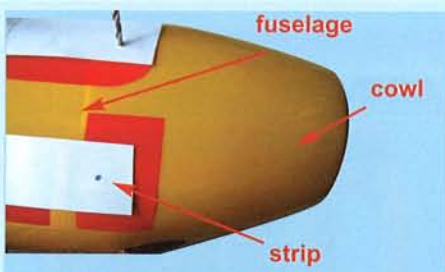

12E- Do not move the cowl. Drill through the dot, the cowl and all four mounting tabs



12F- Secure the cowl into place with four 2x10 [mm] screws



12G- With the **BATTERY & FUSE REMOVED** securely install the propeller

STAGE 13 FITTING THE ELEVATOR AND RUDDER CONTROL HORN

The control horns (see 13A) are installed by using 30 minute epoxy glue to glue the control horn to the elevator and rudder

Install the control horns as shown in 13B, 13C and 13D.

After installing the control horns, wick thin CA such as Pacer ZAP (Pink) into the plywood of the control horn to "harden" the plywood and holes. Do two applications 1 minute apart.



13A- Typical lasercut control horn assembly



13B- Elevator control horn location



13C- Using 30 minute epoxy install the elevator control horn into the elevator control horn location



13D- Rudder control horn location



13E- Using 30 minute epoxy install the rudder control horn into the pre-cut slot

STAGE 14 INSTALLING THE RUDDER AND ELEVATOR SERVOS

Select two suitable micro servos and install the rubber servo grommets & brass ferrules supplied with your radio equipment. The two servos that control the elevator and rudder are to be installed in the servo tray located in the fuselage.

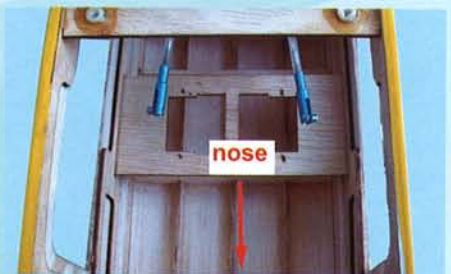

14A- Servo tray

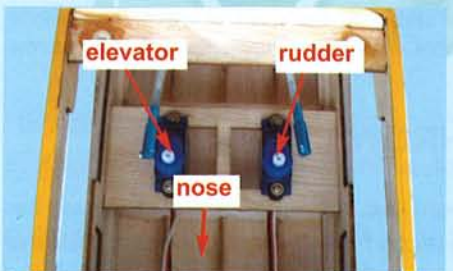

14B- Note the orientation and positions of the two servos in the servo tray

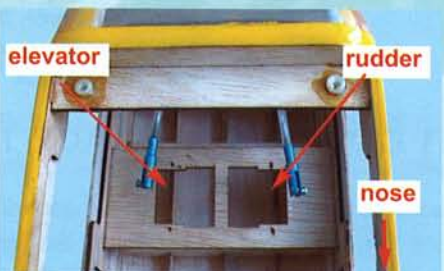

14C- Note the orientation and positions of the elevator and rudder control rods

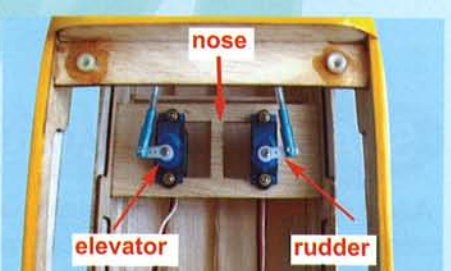

14D- Connect the elevator and rudder control rods to the servo arms

STAGE 15

CONNECTING THE PUSHRODS TO THE RUDDER AND ELEVATOR SERVOS

Consult illustration 15A & carefully ensure that the control rods are connected to the servos correctly

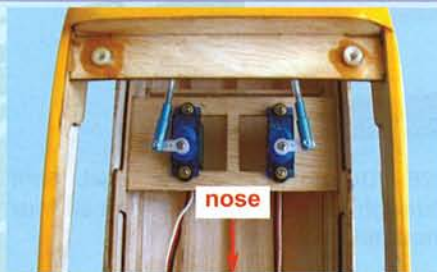

15A- Center the servo control surface and then connect the control rods to the servos using the clevises as shown

STAGE 16

CONNECTING THE PUSHROD TO THE ELEVATOR

Connect the elevator servo to the receiver and turn on your transmitter & then your receiver. Center the transmitter stick

and trim. Adjust the servo arm and clevises to center (not up, not down) the elevator as shown in 16A and 16B.

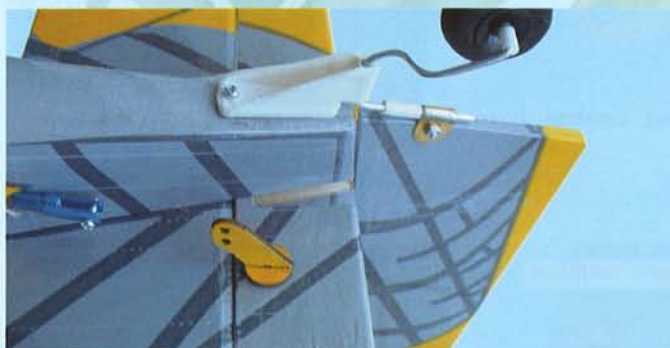

16A- Elevator control horn shown in position



16B- Hold the elevator at neutral (not up, not down). Rotate the clevis to adjust the overall length. Then use the clevis screw to attach the clevis to the control horn. The clevis screw requires a 5/64 in. (2mm) hole. Secure the screw with thread lock

STAGE 17

CONNECTING THE PUSHROD TO THE RUDDER

Connect the rudder servo to the receiver and turn on your transmitter & then your receiver. Center the transmitter stick and trim. Adjust the servo arm and clevises to center (not left, not right) the rudder as shown in 17A.



17A- Hold the rudder at neutral (not left, not right). Rotate the clevis to adjust the overall length. Then use the clevis screw to attach the clevis to the control horn. The clevis screw requires a 5/64 in. (2mm) hole. Secure the screw with thread lock

STAGE 18

ADJUST CONTROL SURFACE THROW LIMITS

Adjust the deflection of the control surfaces to match the specifications on page 12. You can reduce the amount of throw by doing either or both of the following:

- From the servo end, move the clevis to a hole in the servo arm that is closer to the servo output shaft.

- From the control horn end, move the control rod/clevis further out on the horn (away from the control surface). Always confirm that the clevis is firmly attached after making any adjustment.

STAGE 19

FINAL RC SET-UP

Before starting the final set-up of the model, switch on the radio and ensure that all trims are in their neutral positions. Check that the ailerons, elevator and rudder are centered. If any adjustments are needed, do these by uncoupling the relevant clevis and turning it clockwise to shorten the linkage or counter - clockwise to lengthen it. Only when each control surface has been centered mechanically in this way should you begin adjusting the surface movement (or throw)

Now confirm that the control surfaces are moving in the correct direction. Use the servo reversing switches on your transmitter to reverse the direction of a servo if necessary. The most popular transmitter mode (with the throttle on the left, with ailerons and elevator on the right) is shown here.

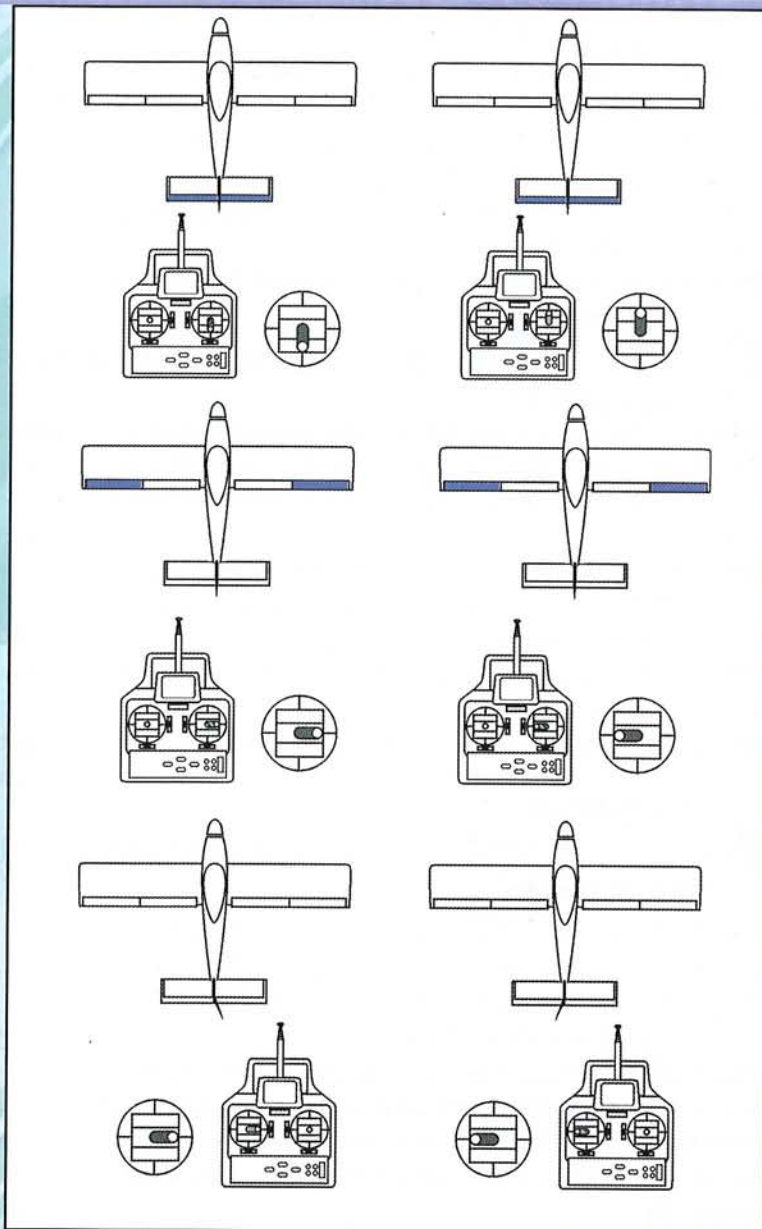

STAGE 20

INSTALLING THE RECEIVER BATTERY (Glow Engine Only)

We have assumed throughout most of these instructions that your DO 27 is being powered by an electric motor and Electronic Speed Control with BEC. Stage 20 applies only if you are using glow power.

Step 20.1 Consult your radio manual for instructions about hooking up your receiver battery, receiver and switch harness.

Step 20.2 Wrap the battery pack securely in foam suitable for RC equipment and wrap the foam insulated pack in a

plastic bag or cling wrap. Position the battery pack under the fuel tank or nearby.

Step 20.3 Thread the battery pack connector back through from beneath the fuel tank to the radio compartment by passing the battery connector through an opening beside or beneath the fuel tank.

Step 20.4 Connect the battery connector to your radio system according to the radio manual.

PLEASE NOTE THAT A FUEL TANK IS NOT SUPPLIED WITH THIS MODEL

STAGE 21

INSTALLING THE RECEIVER

Step 21.1 Consult your radio manual for instructions about hooking up your receiver.

Step 21.2 Plan where you are going to put the receiver with consideration for routing the antenna safely.

Step 21.3 Wrap the receiver securely in foam suitable for RC equipment and wrap the foam insulated receiver in a

plastic bag or cling wrap.

Step 21.4 Generally in the absence of specific instructions from the radio manufacturer, it is recommended that the receiver should be placed where it is least likely to have impact during a crash. Keep the battery pack and other heavy loose items ahead of the receiver.

STAGE 22 CONFIRM RADIO OPERATION

Carefully review how your Electronic Speed Control (ESC) works. Most ESC's will not power up the motor until the throttle has been reduced to zero. Avoid the prop in case the motor suddenly starts to turn.

Step 22.1 Consult your radio manual for instructions about testing and operating your radio system.

Step 22.2 Pay particular attention to charging your batteries

and range testing your system before and after each flight.

Step 22.3 Check that all controls are working correctly before and after each flight.

FOR ELECTRIC POWER, YOU WILL NEED TO INSTALL THE FUSE AND YOUR BATTERY TO TEST YOUR ESC & MOTOR OPERATION

STAGE 23 BALANCING THE AIRCRAFT

Step 23.1 The CG for your DO 27 is located at 2" to 2-1/8" (50 - 55 mm) back from the leading edge of the wing when the wing has been attached to the fuselage as per illustration 24A.

Step 23.2 For the initial flight, the CG should be located at 2" (50mm) back from the leading edge of the wing when the wing has been attached to the fuselage.

Step 23.3 The CG is measured with the motor, battery and all other components installed.

Step 23.4 Set up the CG as it will be when you fly it.

Step 23.5 It is very important to have the CG correct. Flying your model with the CG too far back will likely lead to loss of control and a crash. If you discover that after you have assembled your model and installed your radio, motor and battery that the CG of your model is incorrect you must bring the CG to the correct location by doing the following BEFORE FLYING :

- Move the battery pack fore or aft
- Do not add weight to correct the CG. Move components & especially your battery pack rather than add weight. Only add weight as a measure of last resort.

STAGE 24 CONFIRM MECHANICAL INTEGRITY

Step 24.1 Once you have confirmed that the CG is correct, you should do a thorough review of the entire model before your first flight. Check everything twice! Every hook up, every coupling, everything! Do it twice!!

Step 24.2 Before your first flight, have an experienced flyer review your work. Do not fly your model until it has been checked out by a third party who knows how to fly and how to set up a model aircraft. Do not fly alone. Seek experienced help.

Step 24.3 Once you have completed your first flight, get in the habit of checking your model over before and after each flight! Don't fly if you find something that is not right!

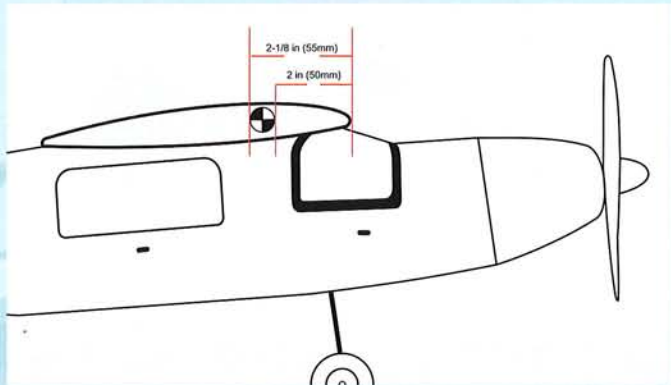

CG location

CONTROL SURFACE THROW SPECIFICATIONS:

The throws are measured at the widest part of the control surface. Adjust the position of the pushrods at the control and/or servo horns to control the amount of throw. You may

also use ATV's if your radio has them but the mechanical linkages should still be set so that the ATV's are near 100% for best servo resolution.

Low rate

ELEVATOR 1/6" (4mm) up

1/6" (4mm) down

AILERON 1/6" (4 mm) up

1/6" (4 mm) down

RUDDER 1/3" (8 mm) right

1/3" (8 mm) left

High rate

1/4" (6 mm) up

1/4" (6 mm) down

1/4" (6 mm) up

1/4" (6 mm) down

2/5" (10 mm) right

2/5" (10 mm) left

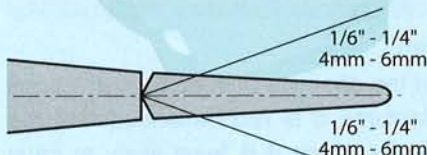

Elevator

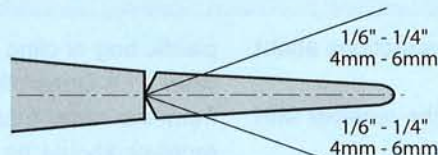

Aileron

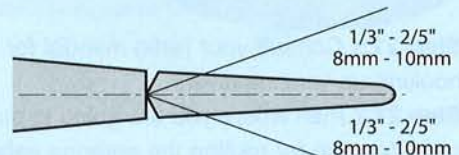

Rudder

STAGE 25 BATTERY LOCATION

The battery location is behind the firewall. To install the battery, you must remove the battery hatch first then connect the battery to your ESC.

Battery packs vary widely in size, shape and type. We recommend using a Lithium Polymer (LIPO) battery.

The battery can be moved fore or aft to adjust the CG to the correct location. See 25C

Once the CG is correct, the battery should be secured in position with Velcro (supplied) and foam cushion material so that the battery cannot move.

DO NOT FLY WITH A LOOSE BATTERY. If the battery moves it will shift the CG location and/or possibly unplug itself causing loss of control.

Once the CG is correct, the battery should be secured in position with Velcro (supplied) or lightweight foam so that the battery cannot move.

After installing your battery and securing it into place, re-install the battery hatch as shown in 25D.

When you are ready to power up your motor, **MAKE SURE YOUR TRANSMITTER IS TURNED ON WITH THE THROTTLE REDUCED TO ZERO & STAY CLEAR OF THE PROP BEFORE INSTALLING THE FUSE.**

After installing the fuse, **STAY CLEAR OF THE PROP** and retain the fuse in place with the security tab.

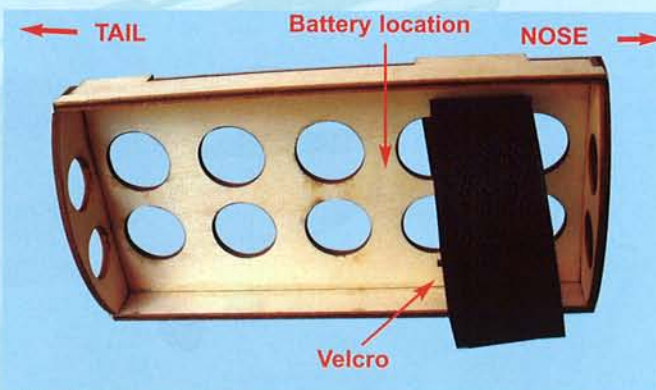

25A- Battery platform



25B- Install the battery platform to the fuselage



25C- Battery installed



25D- Battery hatch installed

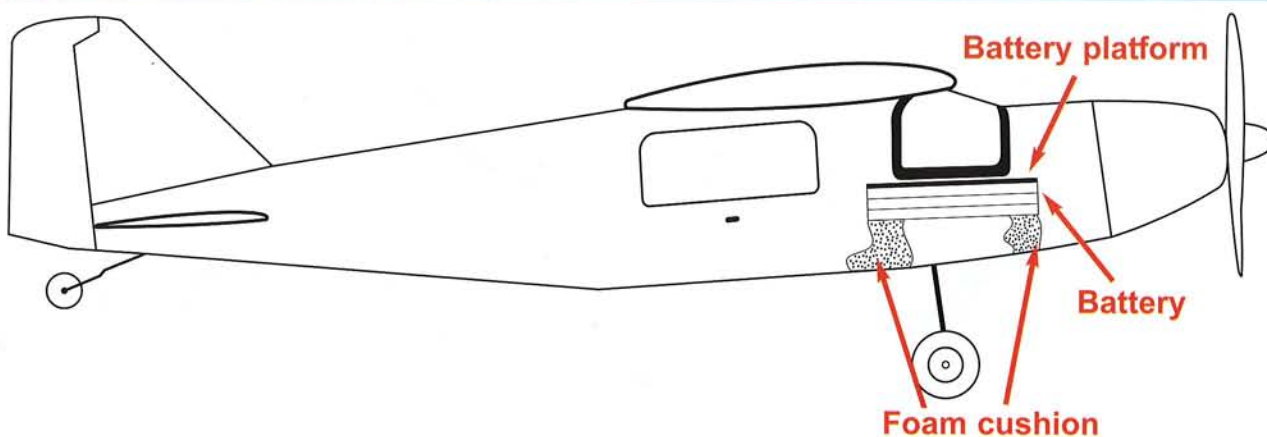

25E- Typical battery arrangement

OTHER VMAR ELECTRIC POWERED ARF MODELS
FOR INFORMATION ABOUT THESE & OTHER
VMAR PRODUCTS PLEASE VISIT US AT...
www.richmondrc.com



BIRDDOG L19 USAF VERSION
Order Ref.: Va.BL19 USAF



BIRDDOG L19 US.ARMY VERSION
Order Ref.: Va.BL19 USAR



AERO SUBARU BLUE
Order Ref.: Va.E-SUBARU B



AERO SUBARU RED
Order Ref.: Va.E-SUBARU R



PIPER CUB J3 YELLOW
Order Ref.: Va.E-J3 CUB Y



