



**JODEL DR400 - 180  
REGENT  
ARF  
SEMI SCALE MODEL**

**WITH POLYCOTE™ ECS  
ENHANCED GRAPHICS SYSTEM**



# Va.112L.0461

**Assembly and Operations Manual**

*Please review this manual thoroughly  
before assembling or operating this model*

**POLYCOTE™ ECS**  
ENHANCED COVERING SYSTEM

This model is covered with our ULTRA TOUGH POLYCOTE ECS Enhanced Covering System. Please see back cover for tips on how to care for & clean POLYCOTE ECS.



## INSTALLING THE PLUG-IN WING

### Stage 1

To install the plug-in wing to the fuselage you will need the following parts.

- 2 aluminum tube spar joiners 3/4 inch (19 mm) diameter
- 2 aluminum collars
- 2 steel nuts (4mm)

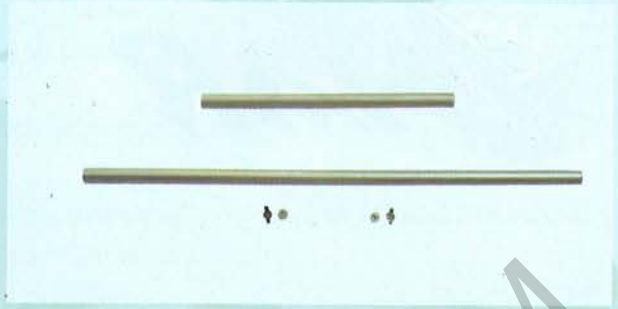

**Step 1.** Turn over the fuselage, by removing screws and pushing slightly to the other end of the hatch cover to take out the cover



1.1 Removed hatch cover

**Step 2.** Insert the front wing spar joiner and then the rear spar joiner (p 1.3 )

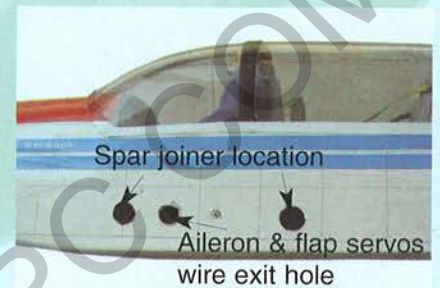

1.2 Wing spar joiner location

**Step 3.** Remove the nut and aluminum collar from the wing root (opposite end of the wing tip)

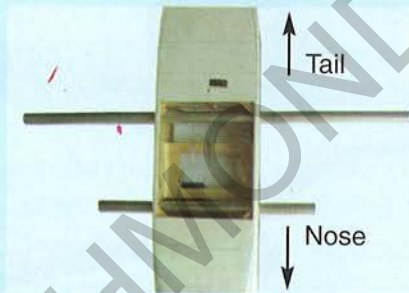

1.3 Install wing spar joiner tubes to the fuselage

**Step 4.** Carefully insert the 2 wing spar joiner tubes into the wing.

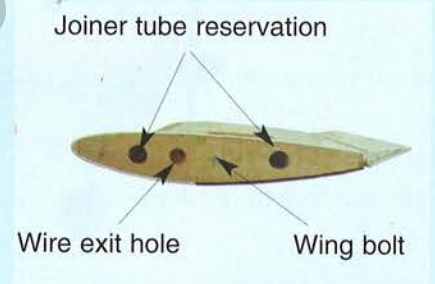

1.4 Wing root

**Step 5.** Insert the collar and tighten the butterfly nut to the wing bolt (p 1.6)



1.5 Plug-in wing panel

**Step 6.** Tighten the hex-bolt on collar to secure the attachment (p 1.7)



1.6 Insert the aluminum collar then tighten the wing bolt

**Step 7.** Repeat this procedure on another wing panel.



1.7 Tighten the hex-bolt on collar to secure the attachment

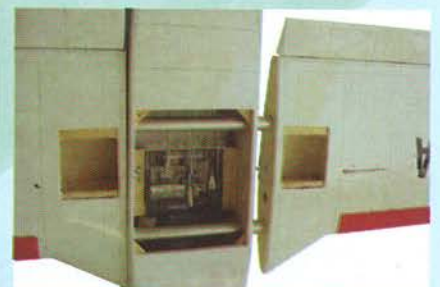

1.8 Repeat this procedure on another wing panel.



## FITTING AILERON SERVOS

### Stage 2

To install the aileron servos into the wing you will need the following items :

- Servo
- Servo mounting screws and grommets as supplied with servos.
- Servo control arms as supplied with the servos.
- Two aileron control rod assemblies supplied with the kit. The assemblies consist of a metal rod with a plastic clevis screwed onto both ends.
- Low tack masking tape.
- 2 aileron control horn assemblies

Carefully remove the white cover plates from the aileron servo cavities. Ensure you know which cover plate is for the right wing and which is for the left. Remove the white cover plates and retain the mounting screws. Notice that there are wooden servo rails pre-installed into each servo cavity end. Locate the wiring harness tubes that are protruding slightly into each aileron servo cavity. The tube can be moved slightly at this point. Check out the other end of each tube for a clean position and then using C/A glue secure the wiring harness tubes at the aileron servo cavity.

Install a servo in each aileron servo cavity and connect the servo wire to the servo extension wires and run the extension wires through wiring harness tubes to the centre of the wing. Install the aileron control horns

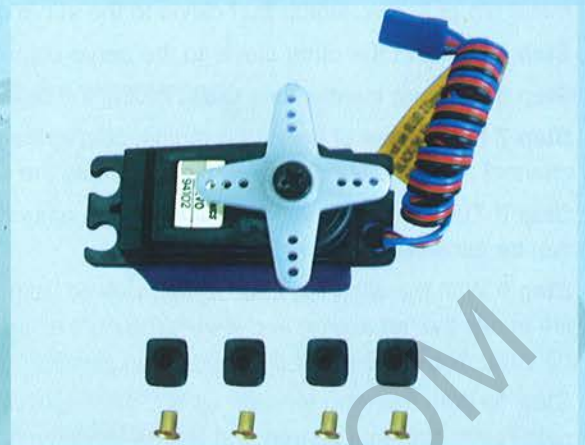

2.1 Prepare the servos by fitting the rubber grommets & ferrules supplied with your radio



2.2 Aileron servo location

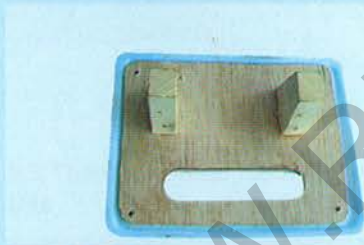

2.3 Aileron servo mount

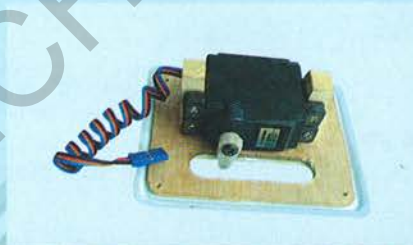

2.4 Screw servo in position



2.5 Install aileron control horn

### Stage 3

**Step 1** Consult your radio instruction manual and center each aileron servos by plugging it into the aileron channel in the receiver. Turn on the transmitter and then the receiver. Center the aileron trim lever on the transmitter. Remove the servo arm mounting screw and the servo arm.

**Step 2** Mount the servo arm back on the servo. Position the arm so that the arm is perpendicular to the surface of the wing. Screw the arm into place with the servo arm mounting screw supplied with the servo.

Locate the two aileron control rods in the hardware bag. Ensure the clevises are well screwed onto the threaded portion of the rod. Rotate and tug aggressively on the clevises and ensure that they are not loose on the rods.

Tape the ailerons into their neutral position so that they are even with the trailing edge of the wing and not pointing either up or down.

**Step 3** Ensure that the aileron control horns are screwed onto the threaded aileron control horn bolts and that both control horns are in approximately the same place on their respective bolts.



**Step 4** Connect the aileron servo rods to the aileron control horns. If one of the two clevises on each rod has a metal pin or screw, attach that clevis to the servo output arm.

**Step 5** Connect the other clevis to the servo output arm

**Step 6** Remove the masking tape holding the ailerons.

**Step 7** In the case of computer radios, couple the servos together by connecting them to the appropriate receiver channel . In the case of analog radios couple the servos together using a Y harness

**Step 8** Turn on your radio and activate the ailerons, using the aileron stick and ensure that a smooth full motion can be achieved.

**Step 9** With the wing top side up and viewed from the back, ensure that moving the transmitter aileron stick to the left raises the left aileron and lowers the right aileron. Movement of the stick to the left will roll the aircraft to the left. (Counterclockwise roll of the wing when viewed from the back ).

**Step 10** With the wing top side up and viewed from the back, ensure that moving the transmitter aileron stick to the right raises the right aileron and lowers the left aileron. Movement of the stick to the right will roll the aircraft to the right.

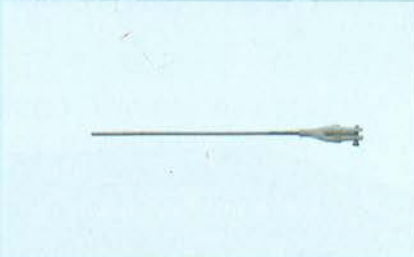

3.1 Aileron control rod assembly



3.2 Aileron control horn assembly



3.3 Aileron control installed

## FITTING FLAP SERVOS

### Stage 4

To install the flap servos into the wings you will need the following items :

- Servos
- Servo mounting screws and grommets as supplied with the servo.
- Servo control arm as supplied with the servo.
- Flap control rod assemblies
- Low tack masking tape.



4.1 Flap control rod assemblies



4.2 Flap servo in each wing

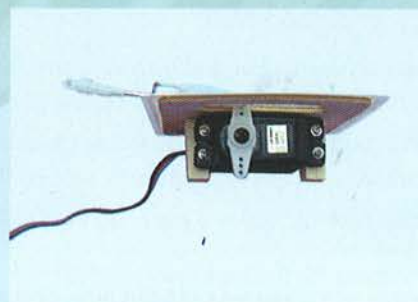

4.3 Flap servo in position



4.4 Final flap installation





4.5 Flap up



4.6 Flap down

## FITTING THE HORIZONTAL AND VERTICAL STABILIZER

### Stage 5

To install the stabilizers to the fuselage you will need.

- Fuselage
- Vertical stabilizers with pre-installed rudder
- Horizontal stabilizers with pre-installed elevator

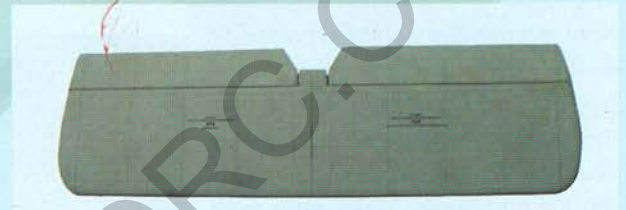

5.1 Horizontal stabilizers with pre-installed elevator

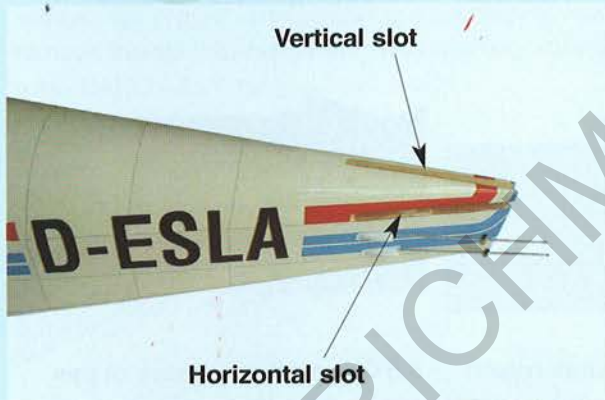

5.2 The completed fuselage slot should look like this



5.3 Vertical stabilizers with pre-installed rudder

### Stage 6

Check the fit of the horizontal stabilizer in its slot. Make sure the tail is square and centre to the fuselage by taking measurements as shown in the diagrams on the right, but don't glue anything yet.

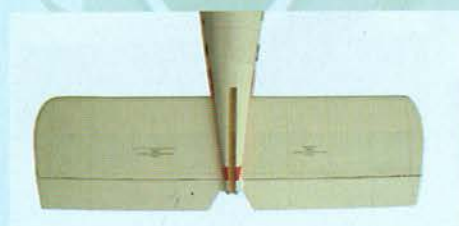

6.1 Trial fit the horizontal stabilizer in its slot

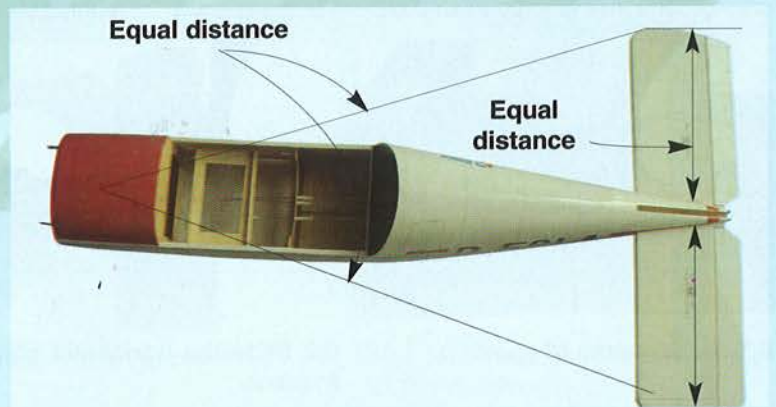



## Stage 7

With the horizontal stabilizer correctly aligned, mark the shape of the fuselage on the top and bottom of the tailplane using a water soluble non-permanent felt-tip pen as shown here.

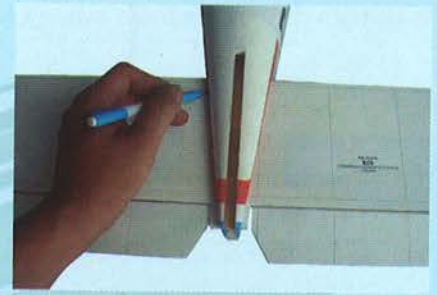

7.1 Mark the top and bottom of the horizontal stabilizer

## Stage 8

Now remove the horizontal stabilizer and, using a sharp knife and a ruler CAREFULLY cut 2mm inside the marked lines and remove the covering on the top and bottom of the tail as shown. **Make sure you only cut the film and not the wood**, otherwise the horizontal stabilizer will be severely weakened.

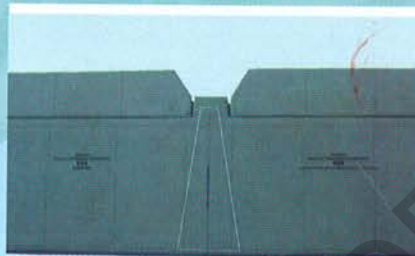

8.1 Marked lines on horizontal stab



8.2 Cutting inside the lines



8.3 Removed covering from top surface



8.4 Exactly the same underneath

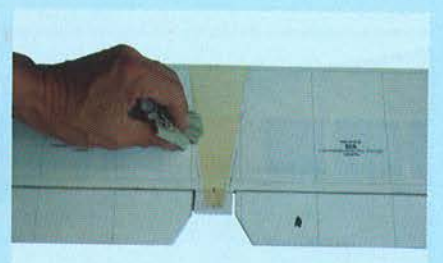

8.5 Clean off any traces of pen

## Stage 9

Now apply sufficient epoxy to the top and bottom of the horizontal stabilizer. Use 30 minute epoxy to ensure a strong bond and give yourself plenty of working time.

Insert the horizontal stabilizers in its slot in the fuselage and re-check the alignment as in Stage 9. Excess epoxy should be cleaned off with a rag or tissue before it cures.

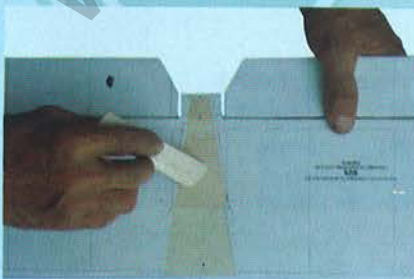

9.1 Apply plenty of epoxy

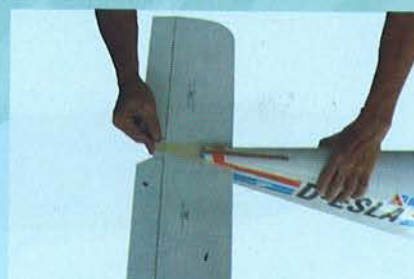

9.2 Slide the horizontal stabilizer in place

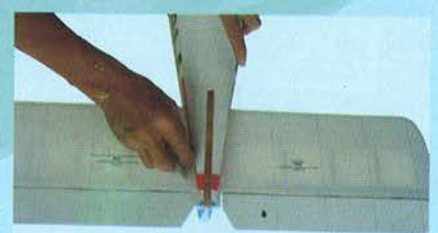

9.3 Wipe off excess epoxy



## FITTING THE VERTICAL STABILIZER WITH RUDDER

### Stage 10

Check the fit of the vertical stabilizer in its slot. Make sure that it is glued square to the horizontal stabilizer and fuselage



10.1 Trial fit the vertical stabilizer onto fuselage.

### Stage 11

Mark the shape of the fuselage on the left and right sides of the vertical stabilizer using a felt-tip pen. Now remove the vertical stabilizer, using a sharp knife & ruler, CAREFULLY cut just 2mm inside

the marked lines and remove the covering on both sides of the fin, just as you did with the horizontal stabilizer, taking sure you only press hard enough to cut the covering, not the vertical stabilizer.



11.1 Mark both sides of the vertical stabilizer



11.2 Carefully cut through the covering



11.3 Remove covering from both sides

### Stage 12

Now apply sufficient epoxy to both sides and the bottom of the vertical stabilizer. Use 30 minute epoxy to ensure a strong bond and give yourself plenty of working time.

Insert the vertical stabilizer in its slot in the fuselage and re-check the alignment. Excess adhesive should be cleaned off with a rag or tissue before it cures.



12.1 Apply plenty of epoxy



12.2 Slide the fin in place



12.3 Insert the pre-installed hinge to the rudder



## FITTING THE NOSE GEAR

### Stage 13

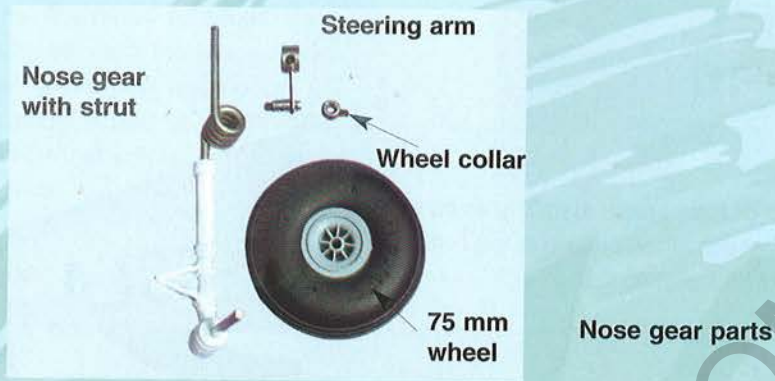

### Stage 14

Fit the nose gear steering arm onto the EZ connector on the steering arm pushrod as per illustration 14.1. Note which way round the arm should be orientated. Now slide the steering arm into the middle of the pre-fitted nylon nose gear bearing.



14.1 Insert the EZ connector threaded shaft through the steering arm, secure with a nut and place the arm into the nylon nose gear bearing



14.2 Nose gear with wheel

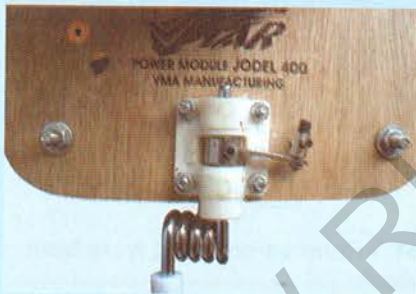

14.3 Holding the nose gear steering arm in place, slide the nose gear into the nylon mount, passing through the steering arm.



14.4 Now tighten the nose gear steering arm



14.5 Loosen the EZ connector bolt to adjust the movement of the nose gear

## FITTING THE MAIN LANDING GEAR

### Stage 15

To install the landing gear, you will need:

- 2 main landing gear assemblies
- 2 main wheels (60mm x 20mm)
- 2 collars
- 4 traps (with 8 mounting screws)

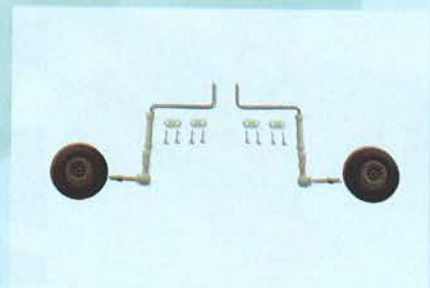

15.1 Main landing gear components



**Step 1.** Turn over the wing to locate the pre-drilled main landing gear mounting holes (photo 15.2)

**Step 2.** Assemble the main landing gear as shown in the photo 15.3

**Step 3.** Fix the main landing gear in to its mounting holes by 2 traps and screws (photo 15.4 - 15.5)

**Step 6.** Tighten the screws

**Step 5.** Repeat this procedure on another side of wing and landing gear.



15.2 Main landing gear location

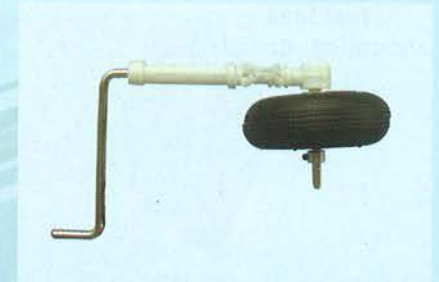

15.3 Main landing gear assembly



15.4 Main landing gear in place



15.5 Main landing gear and landing gear covers in place

## FITTING THE FUEL TANK

### Stage 16

To assemble the fuel tank you will need the following items:

- The fuel tank and fuel stopper assembly (supplied)
- The clunk (supplied)
- About 7" (20 cm) of medium ID silicone fuel line (DUB 197 or similar)
- Cross head Phillips screw driver

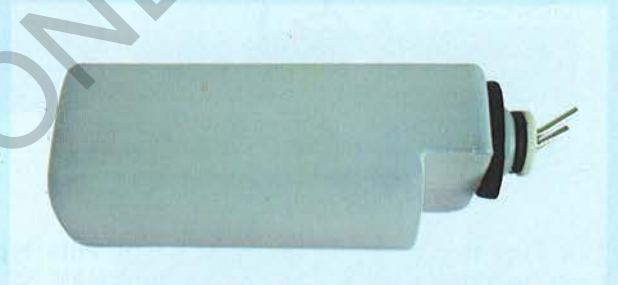

16.1 Use 100 mm (4 in) for fuel line and 50 mm (2 in) for pressure line

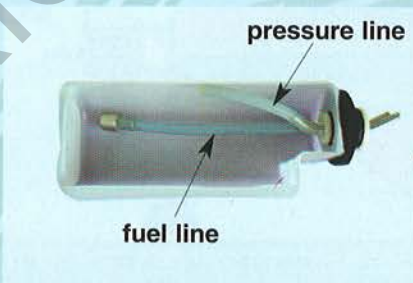

16.2 Illustration of fuel line positioning inside the tank

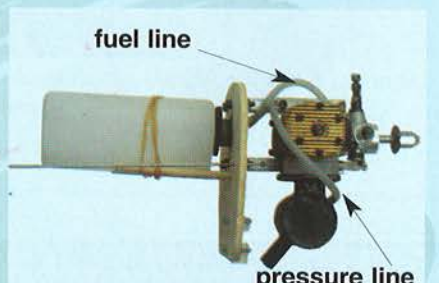

16.3 Fuel tank installed on the power module

## INSTALLING THE ENGINE

### Stage 17

The engine and the fuel tank are installed onto the power module. First remove the power module from the fuselage by removing the 4 nuts & washer



17.1 Power module



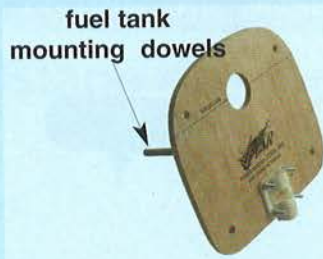

17.2 Power module assembly

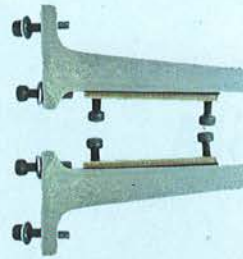

17.3 Aluminum engine mount



17.4 VMAX .52 2 cycle engine recommended



17.5 Fitting the engine to the engine mount

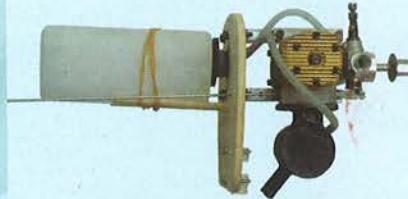

17.6 Engine and fuel tank in position on the power module

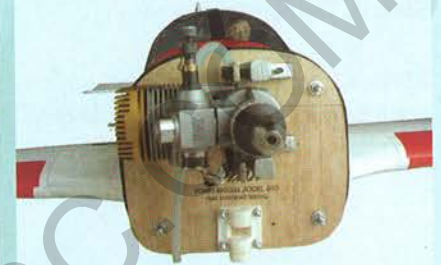

17.7 Engine and engine mount recommended orientation

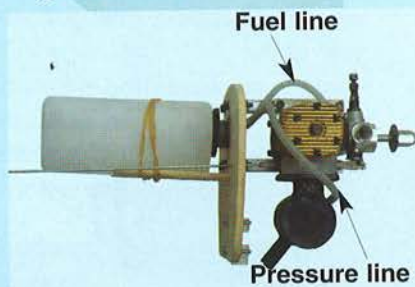

17.8 Fuel line and pressure line hook up to the engine



17.9 Pitts type muffler suitable for VMAX .52



17.10 Fuselage without power module



17.11 Power module mounted to the fuselage



17.12 Power module mounted to the fuselage (side view)



17.13 Cowl installation

## FITTING ELEVATOR AND RUDDER CONTROL HORN

### Stage 18

The elevator control horn is fitted on the underside of both right and left of the elevator halves. Pierce the covering over the pre-drilled hole for the control horns installation as shown.



18.1 Control horn assembly

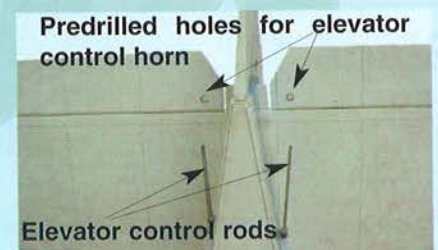

18.2 Elevator control horn position





18.3 Rudder control horn location

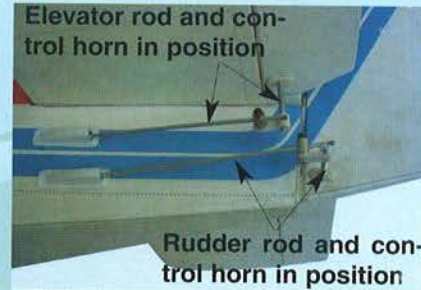

18.4 Elevator and rudder control horn connected to the control rod

## INSTALLING THE SERVOS

### Stage 19

Install the rubber servo grommets and brass ferrules supplied with your radio equipment. The three servos that control the elevator, rudder and throttle are installed in the servo tray mounted in the fuselage. Remove the servo tray from the fuselage. Mount the servos to the servo tray as shown.

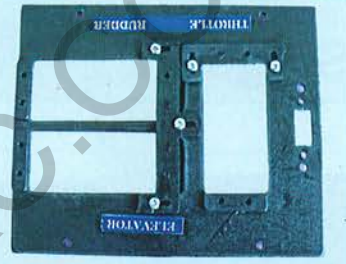

19.1 Universal servo mount

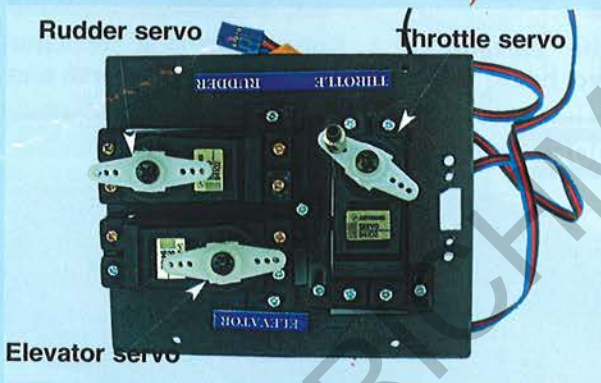

19.2 Note the orientation and positions of the three servos in the servo tray

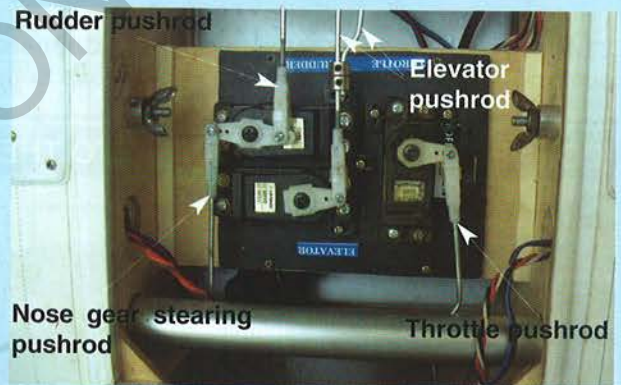

19.3 Throttle, elevator and rudder servos connected to their pushrods

## CONNECTING THE PUSHRODS TO THE THROTTLE, RUDDER AND ELEVATOR SERVOS

### Stage 20

20.1 Consult the picture showing how the throttle, rudder, nose gear steering and elevator servos are positioned and connected to the pushrods (p19.3)

20.1 Pre-installed all pushrods

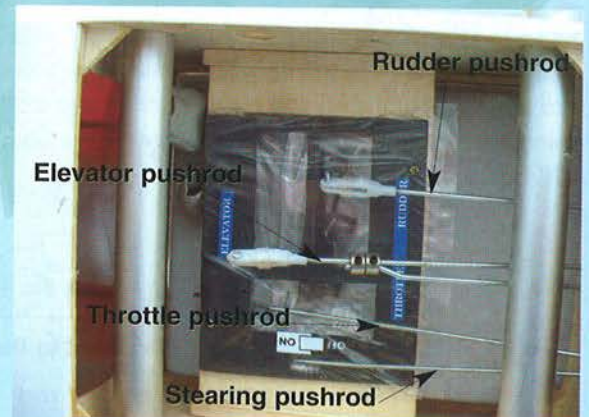





20.2 Install EZ connector to the servo arm

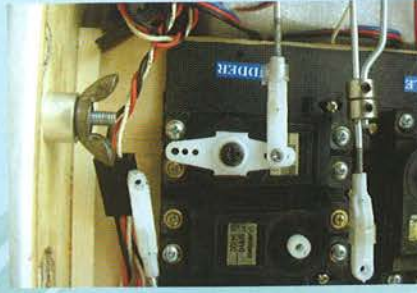

20.3 Connect the rudder pushrod to the rudder servo

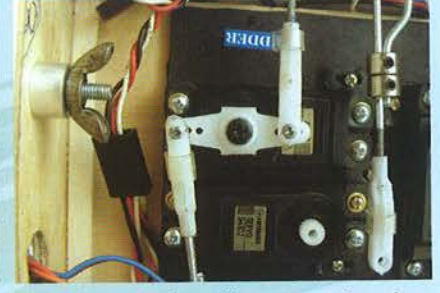

20.4 Connecting the nose steering pushrods to the rudder control

## CONNECTING THE PUSHRODS TO THE ELEVATOR

### Stage 21

Connect the elevator servo to the receiver and turn on your transmitter. Confirm that the neutral positions of the elevator servo are sustained as per illustration 20.4

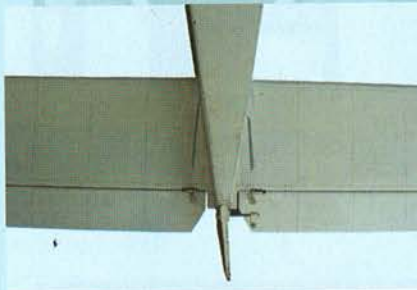

21.1 Pre-installed elevator pushrod



21.2 Connecting the elevator pushrods to the control horn

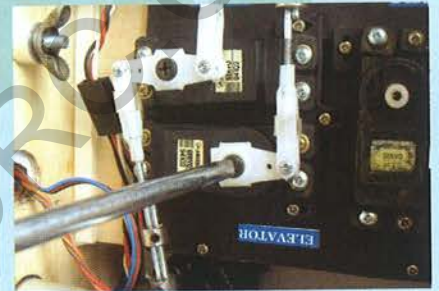

21.3 Connecting the elevator pushrod to the elevator servo arm

## CONNECTING THE PUSHRODS TO THE RUDDER

### Stage 22

Connect the rudder servo to the receiver and turn on your transmitter. Confirm that the neutral positions of the rudder servo are sustained as per illustration 20.4



22.1 Rudder control horn installed and shown in position



22.2 Connecting the rudder pushrod to the rudder control horn

## CONNECTING THE THROTTLE CONTROL

### Stage 23

Connect the clevis to the engine throttle arm at roughly half throttle. Look into the throat of the engine carburettor as you rotate the throttle arm and select a position where the throttle opening is about half what it is when fully open.

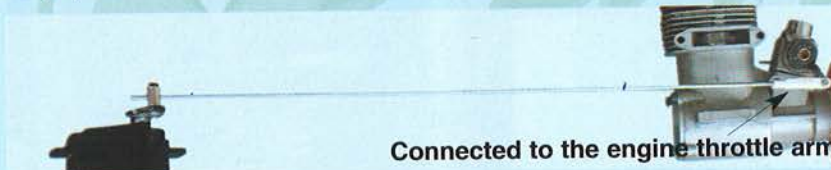

Connected to the engine throttle arm

23.1 Throttle control rod



23.2 Throttle control rod connected to the engine throttle arm



## ADJUST CONTROL SURFACE THROW LIMITS.

### Stage 24

Adjust the deflection of the control surfaces to match the specifications on page 15

You can reduce the amount of throw by doing either or both of the following:

From the servo end, move the clevis or EZ connector to a hole in the servo arm that is closer to the servo output shaft.

From the control horn end, move the horn out further on the threaded bolts. Always confirm that the horn is still thoroughly engaged with the threaded bolt after you have adjusted it.

## FINAL R/C SET-UP

### Stage 25

Before starting the final set-up of the model, switch on the radio and ensure that all trims are in their neutral positions. Check that the ailerons, elevator and rudder are centre. If any adjustments are needed, do these by uncoupling the relevant clevis and turning it clockwise to shorten the linkage or counter-clockwise to lengthen it. Only when each control surface has been centre mechanically in this way should you begin adjusting the surface movement (or throw)



Now confirm that the control surfaces are moving in the correct direction. Use the servo reversing switches on your transmitter to reverse the direction of a servo if necessary. The most popular transmitter mode (with the throttle on the left, with the ailerons and elevator on the right) is shown here.

### Stage 26

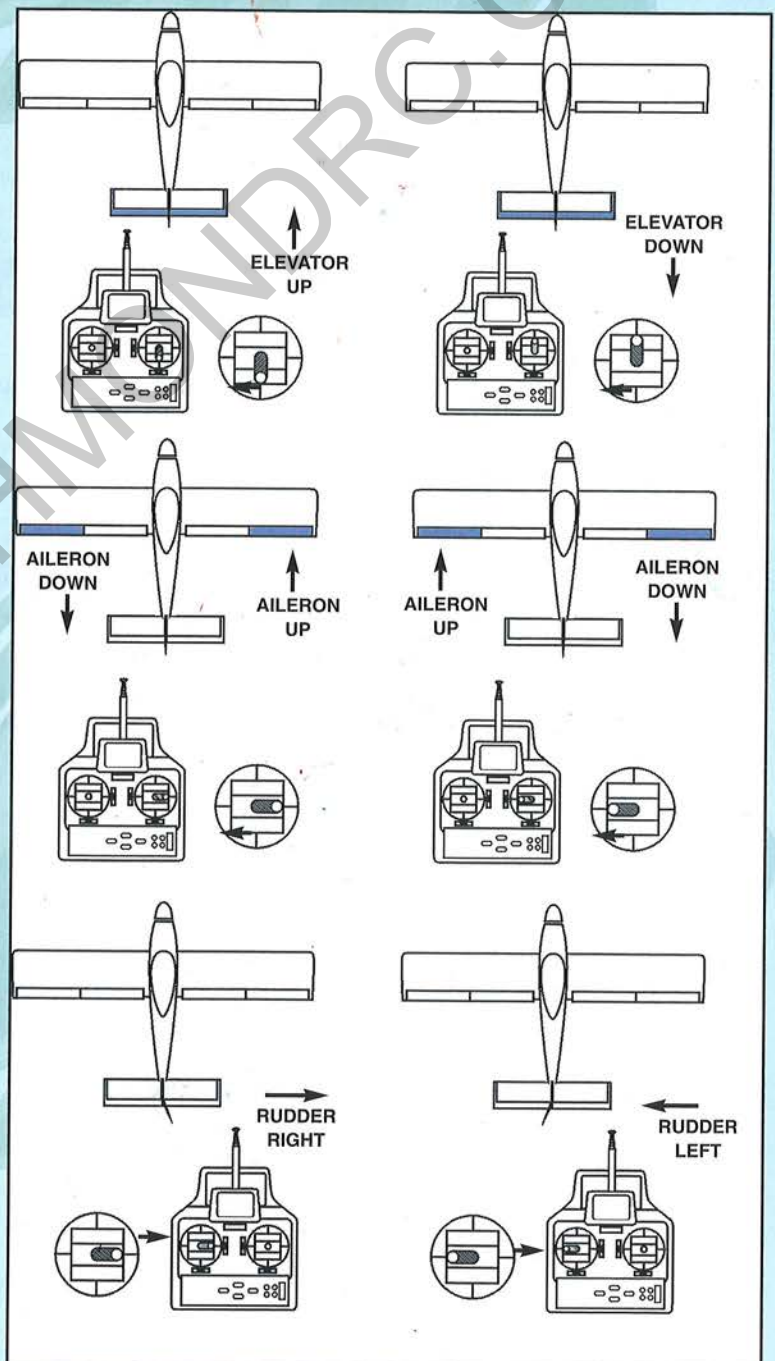



## Stage 27

### INSTALLING THE RECEIVER BATTERY

- 27.1 Consult your radio manual for instructions about hooking up your receiver battery, receiver and switch harness.
- 27.2 Wrap the battery pack securely in foam suitable for RC equipment and wrap the foam insulated pack in a plastic bag or cling wrap.
- 27.3 Thread the battery pack connector back through from beneath the fuel tank to the radio compartment by passing the battery connector through an opening beside the fuel tank.
- 27.4 Connect the battery connector to your radio system according to the radio manual.

## Stage 28

### INSTALLING THE RECEIVER

- 28.1 Consult your radio manual for instructions about hooking up your receiver.
- 28.2 Plan where you are going to put the receiver with consideration for routing the antenna safely.
- 28.3 Wrap the receiver securely in foam suitable for RC equipment and wrap the foam insulated receiver in a plastic bag or cling wrap.
- 28.4 Generally in the absence of specific instructions from the radio manufacturer, it is recommended that the receiver should be placed where it is least likely to have impact during a crash. Keep the battery pack and other heavy loose items ahead of the receiver.

## Stage 29

### CONFIRM RADIO OPERATION

- 29.1 Consult your radio manual for instructions about testing and operating your radio system.
- 29.2 Pay particular attention to charging your radio system batteries and range testing the system before and after each flight.
- 29.3 Check that all controls are working correctly before and after each flight.

## Stage 30

### BALANCING THE AIRCRAFT.

The CG for your JODEL 400 is located at 80 to 90 mm (3 1/6 " to 3 1/2 inch ) back from the leading edge of the wing when the wing has been attached to the fuselage.

**For the initial flight, the CG should be located at 3 1/6" (80mm) back from the leading edge of the wing when the wing has been attached to the fuselage.**

The CG is measured with the engine, radio gear and all other components installed but WITH NO FUEL IN THE TANK.

Set up the CG as it will be when you fly it BUT WITH NO FUEL IN THE TANK.

It is very important to have the CG correct. Flying your model with the CG too far will likely lead to loss control and a crash.

If you discover that after you have assembled your model and installed your radio and engine that the CG is incorrect you must bring the CG to the correct location by doing the following BEFORE FLYING :

- Move the battery pack fore or aft.
- Move other components fore or aft.
- Change engine to a lighter or heavier model.
- Add weight to the nose or tail. If adding it to the nose, try to make it useful by going to a heavier duty engine or adding a spinner with a heavy metal backing plate. As a last resort, add stick on "dead" weight where appropriate.



## Stage 31

### CONFIRM MECHANICAL INTEGRITY

**31.1** Once you have confirmed that the CG is correct, you should do a thorough review of the entire model before your first flight. Check everything twice! Every hook up, every coupling, everything! Do it twice!!

**31.2** Before your first flight, have an experienced flyer review your work. Do not fly your model until it has been checked out by a third party who knows how to fly and how to set up a model aircraft

**31.3** Once you have completed your first flight, get in the habit of checking your model over before and after each flight! Don't fly if you find something that is not right!

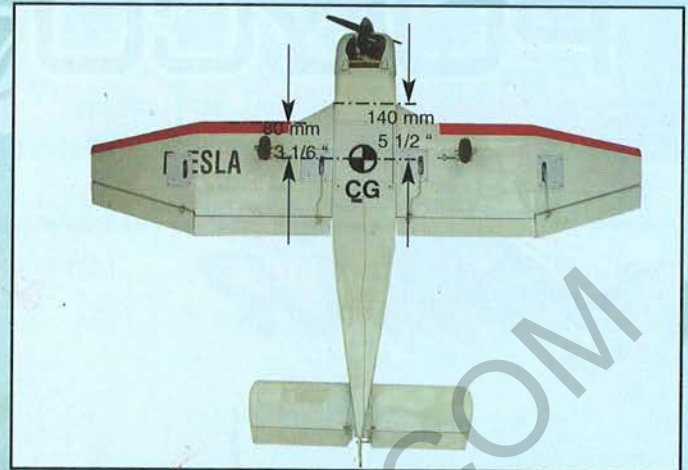

**NOTE :** The throws are measured at the widest part of the elevator, rudder and aileron. Adjust the position of the pushrods at the control/servo horns to control the amount of throw. You may also use the ATV's if your transmitter has them but the mechanical linkages should still be set so that the ATV's are near 100% for best servo resolution.

	High rate	Low rate
ELEVATOR	1/2 " ( 12mm) up 1/2 " ( 12mm) down	1/4" (6 mm) up 1/4" (6 mm) down
RUDDER	1 " (25mm) right 1" (25mm) left	5/8" (16 mm) right 5/8" (16 mm) left
AILERON	3/8" (11mm) up 3/8" (11mm) down	1/3" (8.5 mm) up 1/3" (8.5 mm) down.

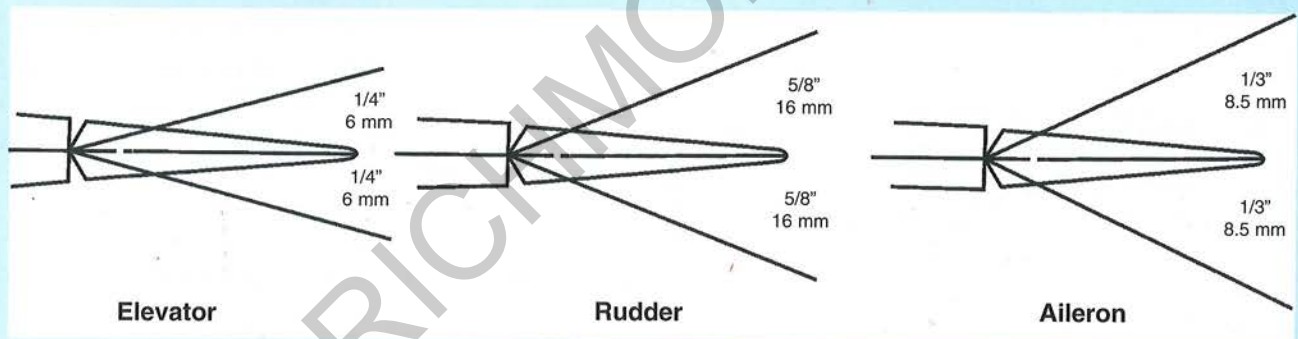

#### Parts for this VMAR Model

In the event that you require replacement parts for you VMAR **JODEL DR400 - 180 REGENT** you can order parts from your retailer or from the VMAR On - line store at [www.richmondrc.com](http://www.richmondrc.com).

Fuselage	# Va.112L.046XF (with servo tray, all rods and pre-installed vert stab and rudder)
Wing set	# Va.112L.046XW (a set of left and right with joiner etc)
Tail set	# Va.112L.046XT (contains horizontal and vertical stabilizers)
Cowl	# Va.112L.046XL (fiberglass)
Canopy set	# Va.112L.046XN (canopy and frame)
Main gear	# Va.112L.046XMG (fiberglass main landing gear with axle set)
Wheel pant set	# Va.112L.046XWP (with main gear fairing set)
Covering set	# Va.112L.046XV (POLYCOTE ECS)
Wing parts bag	# Va.112L.046XWPB (spar joiner, aileron rods ect)
Master bag	# Va.112L.046XMB (as in kit)

For aftermarket parts and other information related to this model see VMAR On - line at [www.richmondrc.com](http://www.richmondrc.com).



# POLYCOTE™ ECS

## ENHANCED COVERING SYSTEM



This model is covered with our ULTRA TOUGH POLYCOTE ECS Enhanced Covering System.



**POLYCOTE ECS is a proprietary Enhanced Covering System engineered in Canada and available only from VMAR.**

With POLYCOTE ECS the graphics are inside the covering... not stuck on top. No Decals! No Layers! No Strips! No Stripes! POLYCOTE ECS utilizes ULTRA TOUGH polyester and our SURE SEAL system to ensure that the seams stay down! Best of all POLYCOTE is totally fuel proof! Quite simply...

POLYCOTE ECS leads the pack in ARF covering systems!

### **CARE & CLEANING OF POLYCOTE ECS.**

**CARE:** Avoid leaving your model in a closed car exposed to direct heating from the sun for lengthy periods. Temperatures under such conditions can exceed 50C (122F) and sagging may occur.

**TIGHTENING:** To tighten POLYCOTE ECS we recommend using a hobby heat gun set for medium heat and a soft cloth. We do NOT recommend an iron. Practice on the bottom of a less noticeable section first. On open bays, heat and then let cool. On solid surfaces, heat and then lock down by rubbing.

**RESEALING SEAMS:** POLYCOTE ECS seams are sealed with our SURE SEAL system and will not normally lift. If you find a loose edge, clean any oil residue from the area and reseal with thin CA.

**PATCHING:** If you should puncture POLYCOTE ECS, clean any oil residue from the area of the paper. Patch with low temperature covering using a heat gun and soft cloth. See Tightening tips above.

**CLEANING:** To clean POLYCOTE ECS we recommend Fantastic household cleaner and disposable paper towels. You can use just about any cleaner and we are not aware of any cleaner that will damage POLYCOTE but it is a good idea to always test a small out of the way spot first. Wipe along seams, not across.

VMAR, POLYCOTE and VMAX are Trademarks of VMAR Manufacturing and appointed VMAR agents worldwide

Copyright VMAR Manufacturing and Richmond RC Supply Ltd 2002 # VMA-T240XIB

[www.richmondrc.com](http://www.richmondrc.com)