

# MODEL ENGINE TEST STAND

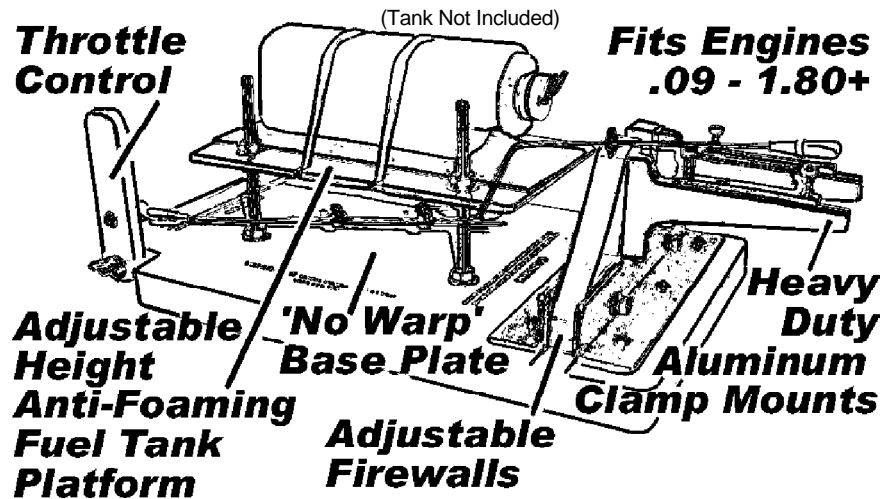

## Assembly and Operations Manual

Please Review This Manual Thoroughly  
**Before Assembling or Operating**  
the  
VMAR Model Engine Test Stand

Visit us on the Web at [www.richmondrc.com/vmar](http://www.richmondrc.com/vmar)

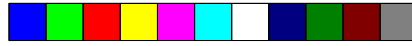

**VMAR Model Engine Test Stand**  
#VMA-ETS120  
Assembly & Operations Manual

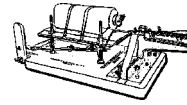

### **Liability Disclaimer**

It is important that the following liability disclaimer be  
**READ BEFORE ASSEMBLING OR USING THIS PRODUCT.**

Model engines, model engine fuel, propellers and tools such as the VMAR Model Engine Test Stand can be hazardous if improperly used. Be cautious and follow all safety recommendations when using your VMAR Model Engine Test Stand. Keep hands, tools, clothing and all foreign objects well clear of the engine when it is operating. Take particular care to safeguard and protect your eyes and fingers and the eyes and fingers of other persons who may be nearby. Use only a good quality propeller that has no cracks or flaws. Stay clear of the propeller and stay clear of the plane of rotation defined by the propeller.

The Manufacturer, Distributor, Retailer and/or other suppliers of this product expressly disclaim any warranties or representations, either expressed or implied, including but not limited to implied warranties of fitness for the purpose of testing model or other engines.

In no event will the Manufacturer, Distributor, Retailer and/or other suppliers of this product have any obligation arising from contract or tort, or for loss of revenue or profit, or for indirect, special, incidental, consequential or other damages arising from the use of this product.

In purchasing and/or using this product, the user accepts all responsibility for its use and accepts all liability associated with such use.

Proceeding with assembly and use of this  
product indicates  
Agreement With and  
Acceptance of the Liability Disclaimer.

#### **Errors and Omissions.**

Corrections to errors or omissions related to the documentation and discovered after the initial printing may be noted on pages 21 and 22.

**BEFORE PROCEEDING:** Please consult pages 21 and 22 and take careful note of any corrections or additional instructions.



**VMAR Model Engine Test Stand**  
 #VMA-ETS120  
 Assembly & Operations Manual

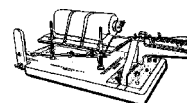

**Thank you for purchasing a VMAR Product.** VMAR Manufacturing is committed to delivering superior value to the RC modeler. Your new VMAR Model Engine Test Stand is the market leader in features, ease of use and flexibility. Please review these instructions before beginning the simple assembly procedure.

We've used metric measurements throughout these instructions. We know that some of you like metric while others think that furlongs per fortnight makes a nifty velocity indicator. If you are in the furlongs camp, bear with us... it's not a big deal... 3 millimetres is stated as 3mm and 3mm is about 1/8 of an inch. Fire up your confuser and you'll find that 25.4mm makes an inch. In places where you have to actually setup something according to a recommended measurement, we've listed an approximate imperial measurement in inches in brackets.

Whenever we've used the directional terms left or right, they are with respect to the engine stand or engine when viewed from the back looking forward.

***Enough already... let's get on with the assembly!***

**INDEX**

1.0 Check out what's in the Box .	Page 4-5
2.0 Overview - How it works.	Page 6-7
3.0 Assembly Procedure.	Page 8-13
3.1 Installing the engine mount T-Beams to the Adjustable Firewalls.	Page 8-9
3.2 Installing the Adjustable Firewalls to the heavy duty Firewall Mounting Rails.	Page 10
3.3 Installing the Fuel Tank Platform.	Page 11-12
3.4 Installing the Throttle Control.	Page 12-13
4.0 Mounting the VMAR Model Engine Test Stand.	Page 13-14
5.0 Mounting an Engine for Testing.	Page 14-15
6.0 Using the VMAR Model Engine Test Stand.	Page 15-16
7.0 Other Items - Needed.	Page 16-17
8.0 Other Items - Optional.	Page 17
9.0 Replacement Parts.	Page 18
10.0 Troubleshooting.	Page 18-19
11.0 Technical Specifications	Page 20
12.0 Errors and Omissions.	Page 21-22
13.0 Notes.	Page 23
11.0 Other VMAR Products.	Page 24

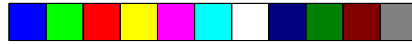

**VMAR Model Engine Test Stand**  
 #VMA-ETS120  
 Assembly & Operations Manual

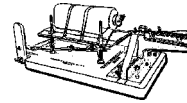

**1.0 Check out what's in the box.**

You've broken the shrink wrap, taken off the lid and grabbed the instruction booklet... you're about an hour away from using your new test stand. Now is the time to take stock of what's in the box. Please go through the contents and do a check off against the following list.

**Missing or damaged components must be reported to your vendor BEFORE any assembly begins.**

1.1 Metal Clamp Type Engine Mount consisting of 2 independent cast aluminum T-Beams.

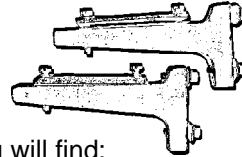

Preinstalled into and onto the T-Beams you will find:

1.1.1 Machine Cap Screws, 4mm x 20mm, black pre-installed into "T" portion of the T-Beams, 2 per T-Beam for a total of 4

1.1.2 Metal Washers, pre-installed with Machine Cap Screws (1.1.1), 2 per T-Beam for a total of 4

1.1.3 Machine Cap Screws, 4mm x 40mm, black, pre-installed into long beam portion of the T-Beams, 2 per T-Beam for a total of 4

1.1.4 Engine Clamp Plates (2) , 10mm x 55mm, pre-installed and held loosely into place with Machine Cap Screws (1.1.3)

And supplied as separate loose parts

1.1.5 Engine Clamp Plates (4), 10mm x 55mm, similar to those of 1.1.4

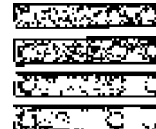

1.2 Adjustable Firewall components consisting of:

1.2.1 Left and right Adjustable Firewalls made of wood and bolted down to Base Plate for shipping purposes. The right Adjustable Firewall has an eyelet screwed into the top edge of it.

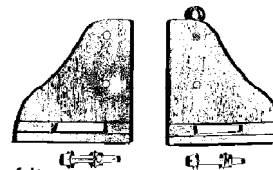

1.2.2 Machine Cap Screws, 4mm x 20mm, black, used to bolt the Adjustable Firewalls to the Base Plate for shipping purposes.

1.2.3 Metal Washers used with Machine Cap Screws (1.2.2)

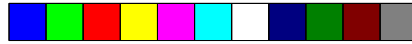

**VMAR Model Engine Test Stand**  
 #VMA-ETS120  
 Assembly & Operations Manual

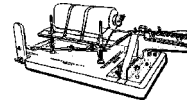

**1.3 Base Plate components**  
 consisting of:

- 1.3.1 Very high density “no warp” Base Plate, 178mm x 300mm
- 1.3.2 Pre-installed heavy duty metal Firewall Mounting Rails.
- 1.3.3 Pre-installed Throttle Arm retaining bolt (1), nut(1), wing nut (1) and washers (3)
- 1.3.4 Pre-drilled Base Plate mounting holes (5)

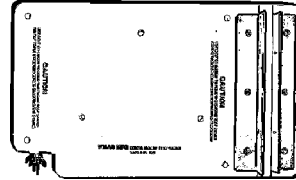

**1.4 Fuel Tank Platform components**  
 consisting of:

- 1.4.1 Plywood sheet, 110mm x 180mm with two slots in each of the long sides and three round holes
- 1.4.2 Metal Bolts (3), 5mm x 97mm
- 1.4.3 Metal Nuts and Washers preinstalled on Metal Bolts (1.4.2). Three Nuts and four Washers per Bolt for a total of 9 Nuts and 12 Washers.
- 1.4.4 Foam sheet for reducing vibration transfer to fuel and thereby reducing the potential of fuel foaming and erratic fuel mixtures.
- 1.4.5 Elastic Bands for installing your fuel tank.

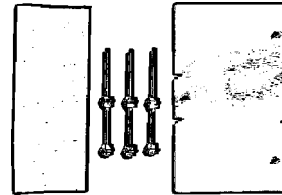

**1.5 Throttle Control components**  
 consisting of:

- 1.5.1 Throttle Arm made of wood with hole in one end and control hook up made from bolt, plastic retainers and plastic horn
- 1.5.2 Control Rod having adjustable length and made of metal with two pre-installed plastic clevises and two wheel collars.



**1.6 Allen Wrench 4mm**



**1.7 Assembly Instruction Booklet**

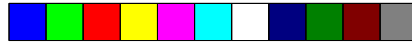

**VMAR Model Engine Test Stand**  
 #VMA-ETS120  
 Assembly & Operations Manual

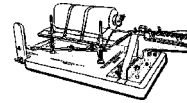

**2.0 Overview – How it Works.** (Expanded Technical 3-Views Page 20)

OK... you've done the check off listed in Section 1. Before you begin the brief assembly procedure, consider how your VMAR Engine Test Stand works.

The very high density “no warp” Base Plate (1.3.1) is the all important foundation of the whole VMAR Model Engine Test Stand. The Base Plate is not just some chunk of commercial plywood, we've selected a very unique material that is perfect at being dead flat and true. By staying dead flat and true, the Base Plate ensures you can clamp down your engine and run it for hours if necessary without stressing the crankcase or engine mounting lugs.

The Base Plate comes with heavy duty Firewall Mounting Rails (1.3.2) that in turn hold the Adjustable Firewalls (1.2.1). By sliding the Adjustable Firewalls closer together or further apart you can accommodate engines from .09 or smaller to 1.80 or larger!

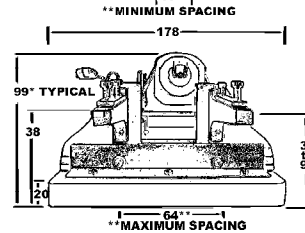
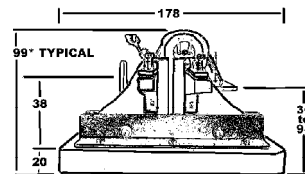

The VMAR Engine Test stand can accommodate engine crankcases that range from approximately 19mm (3/4 in.) to 64mm (2-1/2 in.) in width.

The cast aluminum engine mount T-Beams (1.1) are screwed to the Adjustable Firewalls and the engine being tested is clamped down to the engine mount T-Beams. The engine mount T-Beams have four holes which when used in combination with the three holes in the Engine Clamp Plates (1.1.4) provide for a wide range of engine “lengths”.

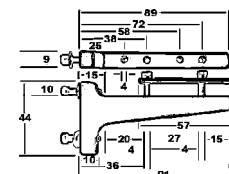

CLAMPS FORWARD

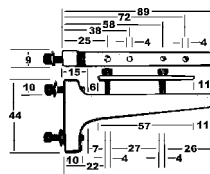

CLAMPS AFT

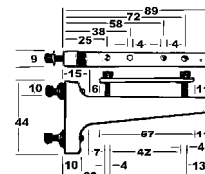

CLAMPS WIDEST



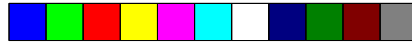

**VMAR Model Engine Test Stand**  
 #VMA-ETS120  
 Assembly & Operations Manual

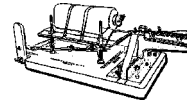

The four extra Engine Clamp Plates can serve as spacers beneath four stroke or other Engines with rear mounted carburetors or exhaust outlets that may need to be lifted to clear the Adjustable Firewalls.

Reliable engine testing and operation is highly dependent upon correct positioning of the fuel tank. We've designed the VMAR Engine Test Stand to provide for easy vertical movement of the tank up or down.

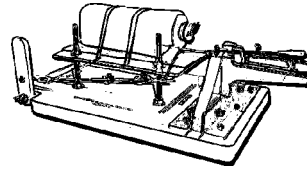

Your engine manual will contain recommended vertical positions of the fuel tank relative to the engine; usually they relate the center line of the tank to the needle valve. You can adjust the Fuel Tank Platform (1.4) up or down using the nuts and washers on the long metal bolts (1.4.2). We use a three bolt system and the Foam Sheet (1.4.4) to ensure that the engine vibration is dampened and to hold the platform steady.

There is nothing worse than lean runs and unreliable fuel mixtures caused by vibration induced fuel foaming. One thing you don't want when breaking in an engine is a lean run. The Foam Sheet and secure three bolt system for the adjustable Fuel Tank Platform help minimize the potential for fuel foaming and unintentional lean running and engine damage caused by air in the fuel.

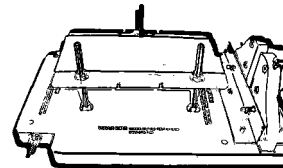

The Throttle Control (1.5) enables you to easily control and retain the throttle setting. The Throttle Arm (1.5.1) is mounted safely back out of the way of the prop and the wing nut enables you to tension the Throttle Arm to keep it in place.

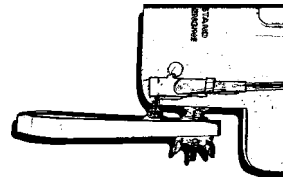

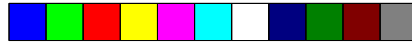

**VMAR Model Engine Test Stand**  
 #VMA-ETS120  
 Assembly & Operations Manual

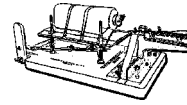

**3 Assembly Procedure.**

By this point, you've gone through the Check Off of all the bits and pieces as described in Section 1 and you've reviewed the Overview Of How It Works as outlined in Section 2. Terrific... you are ready to put the VMAR Model Engine Test Stand together!

Assembly is a four step process. We are going to walk you through each step as follows:

- 3.1 Installing the engine mount T-Beams to the Adjustable Firewalls
- 3.2 Installing the Adjustable Firewalls to the heavy duty Firewall Mounting Rails which have been pre-installed on the Base Plate
- 3.3 Installing the Fuel Tank Platform
- 3.4 Installing the Throttle Control

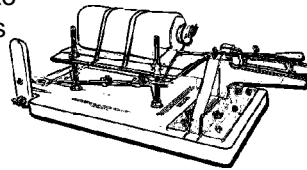

**3.1 Installing the engine mount T-Beams (1.1) to the Adjustable Firewalls (1.2.1)**

3.1.1 Remove the four black Machine Cap Screws (1.1.1) and the four Metal Washers (1.1.2) from the back of the T portion of both of the engine mount T-Beams (1.1)

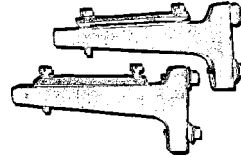

3.1.2. Remove the left and right Adjustable Firewalls (1.2.1) made of wood from where they are bolted down to the Base Plate (1.3.1). Retain the bolts, nuts and washers to be used in the assembly procedure.

3.1.3 Locate the right Adjustable Firewall. It has an eyelet in the top surface.

3.1.4 Mount one of the engine mount T-Beams to the right Adjustable Firewall using two of the black Machine Cap Screws and two of the Metal Washers removed in step 3.1.1. by doing the following:



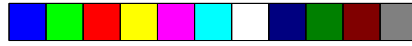

**VMAR Model Engine Test Stand**  
#VMA-ETS120  
Assembly & Operations Manual

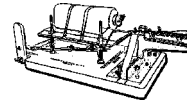

3.1.4.1. Place a Metal Washer on each black Machine Cap Screw

3.1.4.2. Put one of the Machine Cap Screws through the top hole in the right Adjustable Firewall from the back of the right Adjustable Firewall where the holes are countersunk and thread it into the top hole of the T portion of one of the engine mount T-Beams

3.1.4.3. Put one of the Machine Cap Screws through the bottom hole in the right Adjustable Firewall and thread it into bottom hole of the T portion of one of the engine mount T-Beams.

3.1.5 Locate the left Adjustable Firewall. It does NOT have an eyelet in the top surface.

3.1.6 Mount the second of the two Engine T-Beams (1.1) to the left Adjustable Firewall using two of the black Machine Cap Screws and two of the Metal Washers removed in step 3.1.1. by doing the following:

3.1.6.1 Place a Metal Washer on each black Machine Cap Screw

3.1.6.2 Put one of the Machine Cap Screws through the top hole in the left Adjustable Firewall from the back of the left Adjustable Firewall where the holes are countersunk and thread it into the top hole of the T portion of the second engine mount T-Beam.

3.1.6.3 Put one of the Machine Cap Screws through the bottom hole in the left Adjustable Firewall and thread it into bottom hole of the T portion of the second Engine T-Beam.

3.1.7 Using the Allen Wrench supplied, tighten the Machine Cap Screws to securely fasten the engine mount T-Beams to the Adjustable Firewalls.

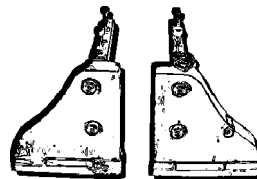

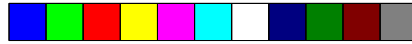

**VMAR Model Engine Test Stand**  
 #VMA-ETS120  
 Assembly & Operations Manual

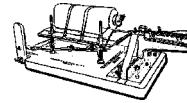

3.2 Installing the Adjustable Firewalls (1.2.1) to the heavy duty Firewall Mounting Rails (1.3.2) which have been pre-installed on the Base Plate (1.3)

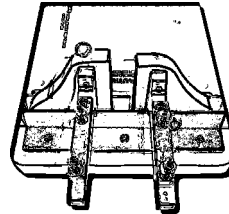

3.2.1 Position the left Adjustable Firewall between the Firewall Mounting Rails so that the slot in the Adjustable Firewall is positioned towards the bottom and the engine mount T-Beam is facing away from the Base Plate. Slide the left Adjustable Firewall towards the left until the bolt holes in the Firewall Mounting Rails are aligned with the slot in the Adjustable Firewall.

3.2.2. Retain the left Adjustable Firewall to the Firewall Mounting Rails using one of the black 4mm x 20mm black Machine Cap Screws (1.2.2), two of the washers and one of the nuts removed in step 3.1.2. Insert the Machine Cap Screw so that the "head" end of the Machine Cap Screw faces away from the Base Plate. Tighten the Machine Cap Screw using the Allen Wrench provided until the Adjustable Firewall is snugly held between the Firewall Mounting Rails but can still be moved back and forth.

3.2.3. Position the right Adjustable Firewall between the Firewall Mounting Rails so that the slot in the Adjustable Firewall is positioned towards the bottom and the engine mount T-Beam is facing away from the Base Plate. Slide the right Adjustable Firewall towards the right until the bolt holes in the Firewall Mounting Rails are aligned with the slot in the Adjustable Firewall.

3.2.2. Retain the right Adjustable Firewall to the Firewall Mounting Rails using one of the black 4mm x 20mm black Machine Cap Screws (1.2.2), two of the washers and one of the nuts removed in step 3.1.2. Insert the Machine Cap Screw so that the "head" end of the Machine Cap Screw faces away from the Base Plate. Tighten the Machine Cap Screw using the Allen Wrench until the Adjustable Firewall is snugly held between the Firewall Rails but can still be moved back and forth.

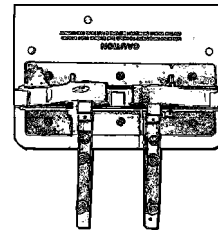

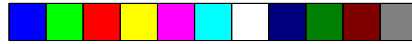

**VMAR Model Engine Test Stand**  
 #VMA-ETS120  
 Assembly & Operations Manual

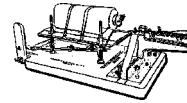

**3.3 Installing the Fuel Tank Platform (1.4)**

3.3.1 Insert the three 5mm x 97mm Metal Bolts (1.4.2) into the three Fuel Tank Platform support bolt holes in the Base Plate (1.3.1) by doing the following...

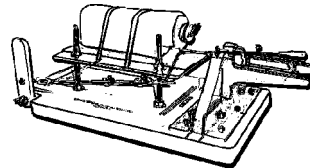

3.3.1.1. Remove the washers and nuts from the Metal Bolts.

3.3.1.2. Locate the three holes in the Base Plate. The three holes are located at the tips of a triangle roughly centered over the Base Plate. Do not use the four holes near the corners of the Base Plate... these are for securing the VMAR Engine Test Stand during use.

3.3.1.3. Place a washer on each bolt and insert the bolts through the holes in the Base Plate from the bottom side of the Base Plate.

3.3.1.4. Place a washer on each bolt from the top side of the Base Plate.

3.3.1.5. Place a nut on each bolt and securely tighten the nuts down on the washers and Base Plate.

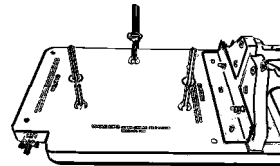

3.3.1.6. Lock the nuts with thread lock such as Pacer Z42 or Loctite 242.

3.3.2. Install the Plywood sheet, 110mm x 180mm (1.4.1) that will become the Fuel Tank Platform by doing the following...

3.3.2.1. Thread a second "leveling nut" on to each of the three bolts until the bottom face of the leveling nut is located approximately 35mm (1-3/8 in.) above the top surface of the Base Plate.

3.3.2.2 Place a washer on each of the three bolts.

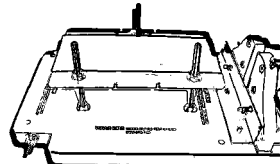

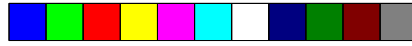

**VMAR Model Engine Test Stand**  
#VMA-ETS120  
Assembly & Operations Manual

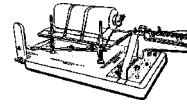

3.3.2.3. Place the Plywood sheet on the three bolts such that the wooden side faces up and the bolts pass through the pre-drilled holes in the Plywood sheet.

3.3.2.4. Level the Plywood sheet by adjusting the leveling nuts up or down

3.3.2.5. Place a washer on each of the three bolts

3.3.2.6. Thread a third nut onto each of the three bolts and tighten each of three nuts down until the Plywood sheet is held securely in place.

3.3.2.7. Lay the Foam Sheet on to the Plywood sheet. You can tack the Foam Sheet to the Plywood sheet with silicone or Pacer Dap-A-Goo if you wish.

3.3.2.8 Select a suitable fuel tank with a capacity of about 300cc (8-10 oz) (Note: ideally you would use a fuel tank that is similar in size and configuration to that intended for the model you plan on using with the engine being tested. For example a smaller tank for small engines and a larger tank for large engines. We have suggested a compromise one tank solution suitable for the bulk of .40-.61 size engines)

3.3.2.9 Attach the fuel tank to the Fuel Tank Platform using the rubber bands supplied by engaging the rubber bands with the four small slots cut into the sides of the Plywood sheet.

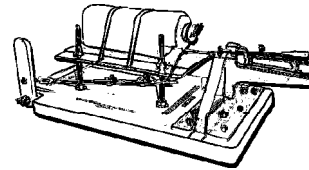

3.4. Install the Throttle Control (1.5) by doing the following:



3.4.1 Unscrew the wing nut from the bolt on the side of the Base Plate.

3.4.2 Remove the outer-most washer from the bolt on the side of the Base Plate.

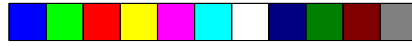

**VMAR Model Engine Test Stand**  
#VMA-ETS120  
Assembly & Operations Manual

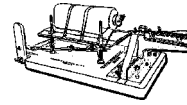

3.4.3 Locate the Throttle Arm made of wood (1.5.1) and place it on the bolt on the side of the Base Plate so that the white plastic horn on the Throttle Arm is facing towards the Base Plate.

3.4.4 Install the washer and wing nut back onto the bolt and tighten the wing nut so that Throttle Arm moves with pressure but not by itself.

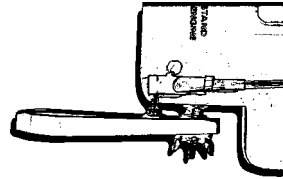

3.4.5 Locate the Control Rod and connect the pre-installed plastic clevis to the plastic horn on the Throttle Arm.

3.4.6 Loosen the two wheel collars on the Control Rod and remove the non-attached portion of the Control Rod.

3.4.7. Position the wire end of the non-attached portion of the Control Rod through the eyelet from the front of the test stand nearest the engine mount T-Beams and then slide it back over the Base Plate until the non-attached portion of the Control Rod can again be attached the other half of the Control Rod using the wheel collars.

#### 4.0 Mounting the VMAR Model Engine Test Stand.

4.1 The VMAR Model Engine Test Stand should be securely mounted to a solid heavy platform such as a table or other flat surface before using. Position the VMAR Engine Test Stand on the platform you have selected in a location that allows the Engine T-Beams to extend beyond one end of the platform.

4.2 There are four holes in the Base Plate, one located approximately at each corner. These will accommodate screws or bolts up to 4.5 mm (3/16 in.) in diameter. If you are using wood screws, ensure the screw is at least 65mm (2-1/2 in.) long. Typically a #12 x 2-1/2 in. wood screw will work for many applications.

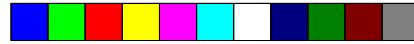

**VMAR Model Engine Test Stand**  
 #VMA-ETS120  
 Assembly & Operations Manual

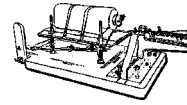

4.3 If you are going to use your test stand in a variety of locations, you might try using large C-clamps to temporarily clamp the Base Plate to a table or other flat surface. We suggest clamping the Base Plate and each end of one of the Firewall Rails.

4.4 Black and Decker makes a product called the Work Mate that serves as a portable vise and table and works well with your VMAR Model Engine Test Stand. The Work Mate is available in a number of different models. Attach the VMAR Engine Test stand to the Work Mate by clamping the Base Plate directly in the Work Mate or by attaching a clamping bar to the bottom of the Base Plate with suitable wood screws.

4.5 In all cases, when mounting the VMAR Model Engine Test Stand, ensure that it is securely attached to a solid flat surface and that it will remain securely attached when under load and vibration from your Engine.

## 5.0 Mounting an Engine for Testing.

Once you've assembled your VMAR Model Engine Test Stand and attached it securely to a solid heavy flat platform, you are ready to mount an engine.

5.1 Remove the 4mm x 40mm black Machine Cap Screws (1.1.3) from the long beam portion of the engine mount T-Beams (1.1) and remove the engine Clamp Plates (1.1.4)

5.2 Position your engine on the engine T-Beams and slide the Adjustable Firewalls (1.2.1) so that the engine mounting lugs are well and completely located on the engine mount T-Beams.

5.3 Secure the Adjustable Firewalls in place between the Firewall Mounting Rails (1.3.2) using the Allen Wrench (1.5) to tighten the 4mm x 20mm black Machine Cap Screws (1.2.2)

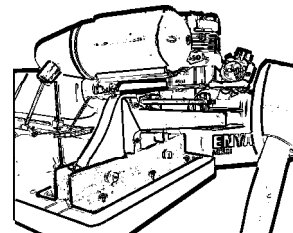

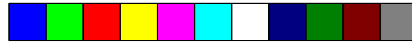

**VMAR Model Engine Test Stand**  
#VMA-ETS120  
Assembly & Operations Manual

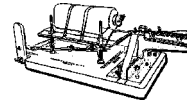

5.4 Reinstall the engine Clamp Plates on the engine T-Beams using the 4mm x 40mm black Machine Cap Screws and noting carefully which holes in the engine Clamp Plates work best for clearing the engine lugs and engaging with receiving holes in the engine mount T-Beams.

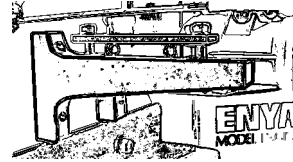

5.5 Tighten the engine Clamp Plates and engine securely into place using the 4mm x 40mm black Machine Cap Screws.

## 6.0 Using the VMAR Model Engine Test Stand.

6.1 Ensure that your VMAR Model Engine Test Stand is securely attached to a solid heavy flat platform and that the engine to be tested is securely clamped into place.

6.2 Review the instructions that came with your engine and adjust the height of the fuel tank accordingly. In the absence of any suitable instructions about height of fuel tank, we recommend that the height of the fuel tank be such that the horizontal centre line of the fuel tank is approximately 6mm (1/4") below the fuel feed line where it enters the carburetor of the engine. If in doubt set the fuel tank slightly higher rather than lower. Low fuel tanks tend to cause fuel draw problems and leaner running with some engines.

6.3 Connect appropriate fuel lines from the fuel tank to the engine

6.4 Connect the Throttle Control Rod to the engine throttle arm using the clevis supplied. Adjust the length of the Throttle Control Rod by loosening the wheel collars and retightening them once a suitable length has been determined.

6.5 Review the instructions that came with your engine and select a suitable prop and fuel. If you are breaking in an engine note carefully any specific instructions from the engine manufacturer about prop size when breaking in an engine. In the absence of any specific instructions about engine break-in, it is generally good practice to use a prop that has a lower pitch and slightly higher diameter when breaking in an engine.

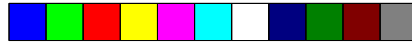

**VMAR Model Engine Test Stand**  
#VMA-ETS120  
Assembly & Operations Manual

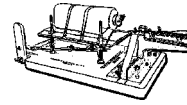

6.6 Review and follow the starting and operating instructions that came with your engine. If you are breaking in an engine, note carefully any specific instructions from the engine manufacturer about engine break-in. In the absence of any specific instructions about engine break-in, it is generally good practice to run the engine rich with a range of throttle settings and for short periods (minutes) of time alternated with periods of cool down. Although many engines can be flown after a very short break-in period it is common to repeat the rich variable throttle runs followed by cool down periods until the engine has 30-60 minutes of total run time before attempting to use the engine in a flying model.

### 7.0 Other Items - Needed

The following items are considered essential for the satisfactory and safe operation of the VMAR Model Engine Test Stand. Model engines and model engine fuel can be hazardous if improperly used. See Safety equipment noted below.

- Engine
- Propeller
  - Suitable for engine size.
- Glow Plug
  - Suitable for engine size and type.
- Fuel Tank
  - Suitable for engine size. See engine manual for requirements. The Fuel Tank Platform can accommodate fuel tanks up to 65mm wide x 175mm long.
  - 300cc (8-10oz) for most applications.
    - #RRC-TANK300 (300cc), or
    - #DUB-408 (8 oz.), or
    - #DUB-410 (10 oz.)
- Fuel
  - Suitable for engine.
- Fuel Line suitable for Fuel
  - #DUB-222 (2 ft. Silicone) for Glow Fuel, or
  - #DUB-225 (3 ft. Neoprene) for Gas, Oil, Diesel or Glow Fuel
- Tools
  - Phillips Screwdriver
  - Pliers



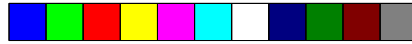

**VMAR Model Engine Test Stand**  
#VMA-ETS120  
Assembly & Operations Manual

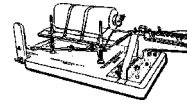

**Other Items - Needed (cont'd)**

- Hardware to Mount Test Stand to a solid heavy level platform
  - C-Clamps (2-4), or
  - #12 x 2-1/2 in. Wood Screws (4), or
  - 3/16 x 2-1/2 in. Lag Bolts.
- Safety Equipment suitable for working around Model Engines.
  - Eye Protection.
  - Finger Protection.
  - Ear Protection.

Phillips Screw Driver

**8.0 Other Items - Optional**

The following items are optional and not required for the satisfactory operation of the VMAR Model Engine Test Stand. They will make the task of using the Test Stand and/or a model engine easier.

- Adhesives
  - To secure Foam Sheeting under Tank
    - Pacer Dap-A-Goo, or
    - Silicone.
  - To Lock Fuel Tank Platform adjustment bolts to Base Plate
    - Pacer Z42 Thread Locker, or
    - Loctite 242, or
    - Pacer Zap-A-Gap Cyanoacrylate.
- Tools
  - Ball Wrench 4mm - with handle - #DUB-451.
  - Chicken Stick or Electric Starter.
  - Glow Ignitor.
  - Fuel Pump
    - Hand Crank #MTC-1210
    - Squeeze Type #DUB-519
    - Electric #MTC-1220
  - Power Source such as #RRC-LEAD1270 - 12Volt / 7Amphour Battery if using Electric Starter and/or Electric Fuel Pump
  - VMAR Power Tote #VMA-PT109 to carry tools etc.
- Spinner
  - Suitable for engine and propeller.
- Fueling Valve
  - #DUB-334 for Glow Fuel
  - #DUB-335 for Gas

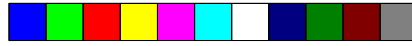

**VMAR Model Engine Test Stand**  
#VMA-ETS120  
Assembly & Operations Manual

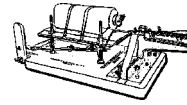

## 9.0 Replacement Parts.

The VMAR Model Engine Test Stand utilizes heavy duty components designed to last for years. If parts are required, please reference the items and part numbers below. We recommend the use of genuine brand name parts.

- 4mm Allen Wrench - #DUB-2131
- Cast aluminum clamp type T-Beam engine mounts (pair) - #RRC-MOUNTUNI
- Throttle Control Parts
  - Rods (2) - #DUB-123 (x2) or #DUB-184
  - Clevises (2) - #DUB-122
  - Wheel Collars (5/32) to join rods (2) - #DUB-140
- Assembly & Operations Manual (#VMA-ETS120IB)

## 10.0 Troubleshooting.

10.1 Left vs. Right throttle hook ups. Most engines have their throttle arm located on the right side of the engine and the Throttle Control provided with your VMAR Model Engine Test Stand has been setup with this in mind. For engines that have their throttle arm located on the left side of the engine, you can easily remove the Throttle Control Arm and Rods and relocate them to the left side of the Test Stand. Leave the Control Arm threaded stud in place, secure the arm on the left with a new flat head screw and tension it accordingly.

10.2 Some engines have exhaust stacks and/or carburetors located on the back of the engine and these may contact the Adjustable Firewalls when you try to clamp your engine down. We have provided two extra sets of engine Clamp Plates that can be used to lift the engine higher to allow the rear mounted components to clear the Adjustable Firewalls. If you need to lift your engine higher on the T-Beams, place either one set or both sets of extra clamps on the T-Beams so that they lie beneath the engine lugs. Install the original engine Clamp Plates so that they are above the engine lugs and tighten these top most Clamp Plates to securely attach your engine to the engine mount T-Beams.

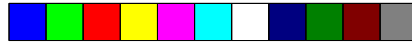

**VMAR Model Engine Test Stand**  
 #VMA-ETS120  
 Assembly & Operations Manual

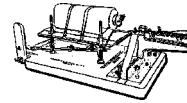

In extreme cases, if lifting the engine with the extra Clamp Plates still does not provide enough rear clearance, consider removing the engine mount T-Beams from the Adjustable Firewalls and installing some additional spacers in the form of washers between the T-Beams and the Adjustable Firewalls. Tighten securely and evenly when reinstalling. This has the effect of making the T-Beams "longer".

10.3 If you find that the mounting lugs on your engine appear to be too wide or have spacing that is not compatible with the VMAR Model Engine Test Stand, you have a couple of options. First, we'd suggest removing from each engine mount T-Beam one of the black Machine Screws and trying to position the engine lug so that a slightly smaller bolt can be passed through the Clamp Plate, through the engine lug and through the T-Beam threaded holes to engage with a nut installed below the T-Beams.

If this does not work, you can remove the engine Clamp Plates completely and either tap new holes in the T-Beams or drill non-tapped holes and use mounting bolts and nuts to hard mount the engine to the T-Beams.

In all cases, make sure the engine is securely mounted to the T-Beams before operating the engine.

10.4 If you have problems with the using your VMAR Model Engine Test Stand, please check out the Discussion Groups, Frequently Asked Questions and other related information at [www.richmondrc.com](http://www.richmondrc.com).

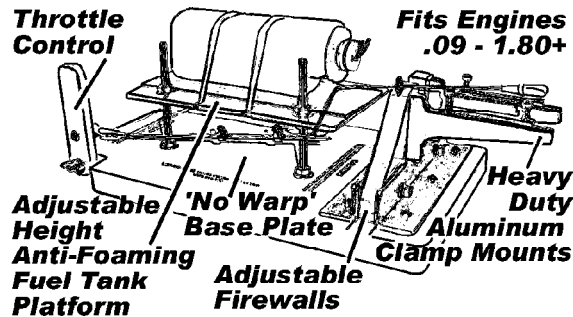

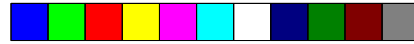

**VMAR Model Engine Test Stand**  
 #VMA-ETS120  
 Assembly & Operations Manual

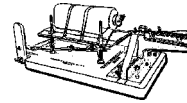

**11.0 Technical Specifications. [mm] (25.4mm = 1 inch)**

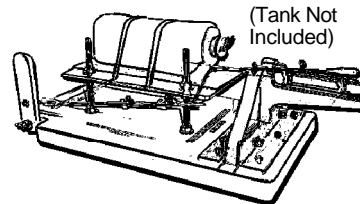
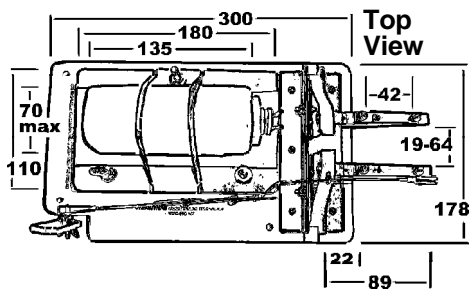
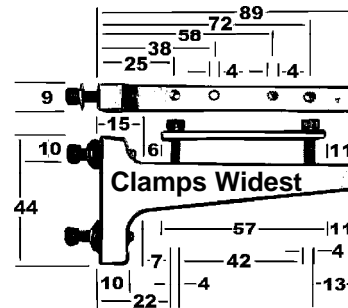
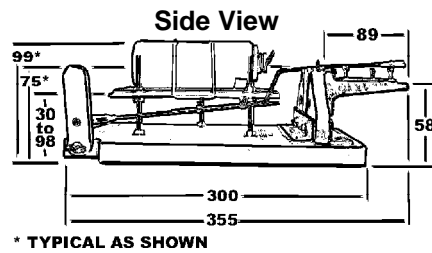
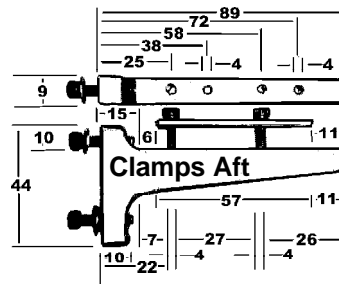
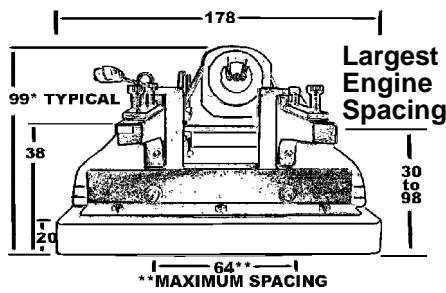
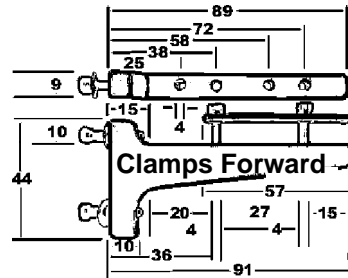
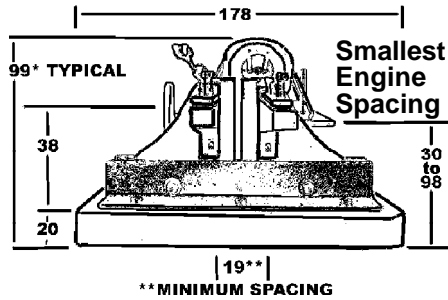

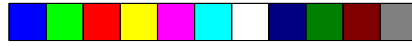

**VMAR Model Engine Test Stand**  
#VMA-ETS120  
Assembly & Operations Manual

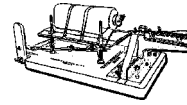

**12.0 Errors and Omissions.**

This page was last updated 990812. Please check our web site at [www.richmondrc.com/vmar](http://www.richmondrc.com/vmar) for the latest information related to this product.

No errors or omissions noted as of this printing. Please check our web site at [www.richmondrc.com/vmar](http://www.richmondrc.com/vmar) for the latest information related to this product.

The rest of this page has been left intentionally blank.



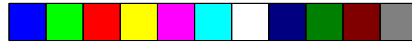

**VMAR Model Engine Test Stand**  
#VMA-ETS120  
Assembly & Operations Manual

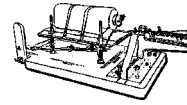

### 12.0 Errors and Omissions (cont'd)

This page was last updated 990812. Please check our web site at [www.richmondrc.com/vmar](http://www.richmondrc.com/vmar) for the latest information related to this product.

No errors or omissions noted as of this printing. Please check our web site at [www.richmondrc.com/vmar](http://www.richmondrc.com/vmar) for the latest information related to this product.



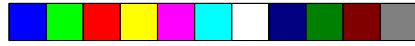

**VMAR Model Engine Test Stand**  
 #VMA-ETS120  
 Assembly & Operations Manual

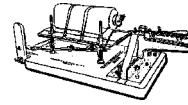

**13.0 Notes**



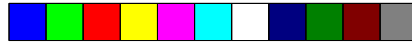

**VMAR Model Engine Test Stand**  
#VMA-ETS120  
Assembly & Operations Manual

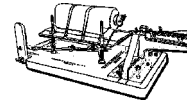

**14.0 Other VMAR Products.**

VMAR Manufacturing makes an extensive range of products including the VMAR Model Aircraft Test Stand and a full line up of Almost Ready to Fly "ARF" model aircraft that go from box to flight line in just hours. VMAR products are distributed through selected agents and hobby retailers worldwide. For further information about other VMAR products and how to purchase them in your area please visit our web site at [www.richmondrc.com/vmar](http://www.richmondrc.com/vmar)

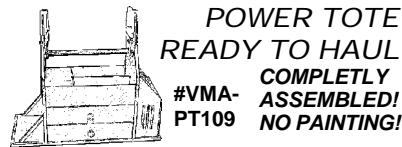
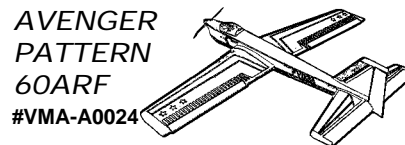
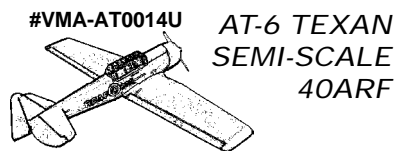
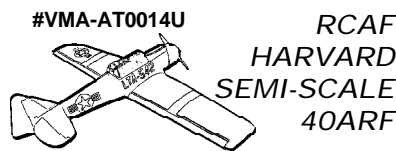
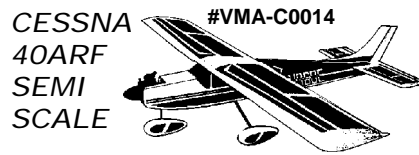
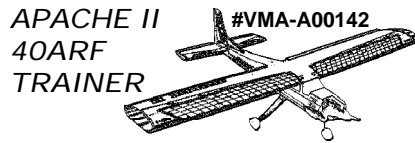

#VMA-ETS1201B

copyright 1999